















PARACOPPA SPECIFICO - OIL CARTER PROTECTION
 SABOT MOTEUR SPECIFIQUE - SPEZIFISCHER MOTORSCHULTZ - CUBRE CARTER ESPECIFICO

SUZUKI DL650 V-STROM L2

2011 - 2012

ISTRUZIONI DI MONTAGGIO - MOUNTING INSTRUCTIONS
 INSTRUCTIONS DE MONTAGE - BAUANLEITUNG - INSTRUCCIONES DE MONTAJE

<p>①</p>  <p>PARACOPPA OIL CARTER PROTECTION SABOT MOTEUR SPEZIFISCHER MOTORSCHULTZ CUBRE CARTER</p> <p>Q.TY n.1</p>	<p>②</p>  <p>PIASTRINA LITTLE PLATE PETITE PLAQUE PLAETTCHEN PLAQUETA GL2137</p> <p>Q.TY n.1</p>	<p>③</p>  <p>PIASTRINA LITTLE PLATE PETITE PLAQUE PLAETTCHEN PLAQUETA GL2139</p> <p>Q.TY n.1</p>	<p>④</p>  <p>PIASTRINA CENTRALE CENTRAL LITTLE PLATE PETITE PLAQUE CENTRALE ZENTRUM PLAETTCHEN PLAQUETA CENTRAL</p> <p>Q.TY n.1</p>	<p>⑤</p>  <p>VITE TEF M6x16mm SCREW VIS SCHRAUBE TORNILLO</p> <p>Q.TY n.2</p>	<p>⑥</p>  <p>VITE TBEI M6x25mm SCREW VIS SCHRAUBE TORNILLO</p> <p>Q.TY n.2</p>		
<p>⑦</p>  <p>VITE TE M10x120mm SCREW M10x120mm VIS M10x120mm SCHRAUBE M10x120mm TORNILLO M10x120mm</p> <p>Q.TY n.1</p>	<p>⑧</p>  <p>VITE TBEIFN M6x16 SCREW SCREW VIS SCHRAUBE TORNILLO</p> <p>Q.TY n.4</p>	<p>⑨</p>  <p>RONDELLA Ø6x18 nera WASHER Ø6x18 black RONDELE Ø6x18 noire SCHEIBE Ø6x18 schwarz ARANDELA Ø6x18 negra</p> <p>Q.TY n.2</p>	<p>⑩</p>  <p>RONDELLA Ø10mm WASHER Ø10mm RONDELE Ø10mm SCHEIBE Ø10mm ARANDELA Ø10mm</p> <p>Q.TY n.2</p>	<p>⑪</p>  <p>RONDELLA ZIGRINATA Ø6 WASHER Ø6 RONDELE Ø6 SCHEIBE Ø6 ARANDELA Ø6</p> <p>Q.TY n.4</p>	<p>⑫</p>  <p>DADO A.B. M6 FLANGIATO BOIT M6 ECROU M6 MUTTER M6 TUERCA M6</p> <p>Q.TY n.2</p>	<p>⑭</p>  <p>DADO A.B. M10 BOIT M10 ECROU M10 MUTTER M10 TUERCA M10</p> <p>Q.TY n.1</p>	<p>⑬</p>  <p>DISTANZIALE Ø10x9.8mm foro Ø8.2mm SPACER ENTRETOISE DISTANZSTUECK DISTANCIADOR</p> <p>Q.TY n.2</p>

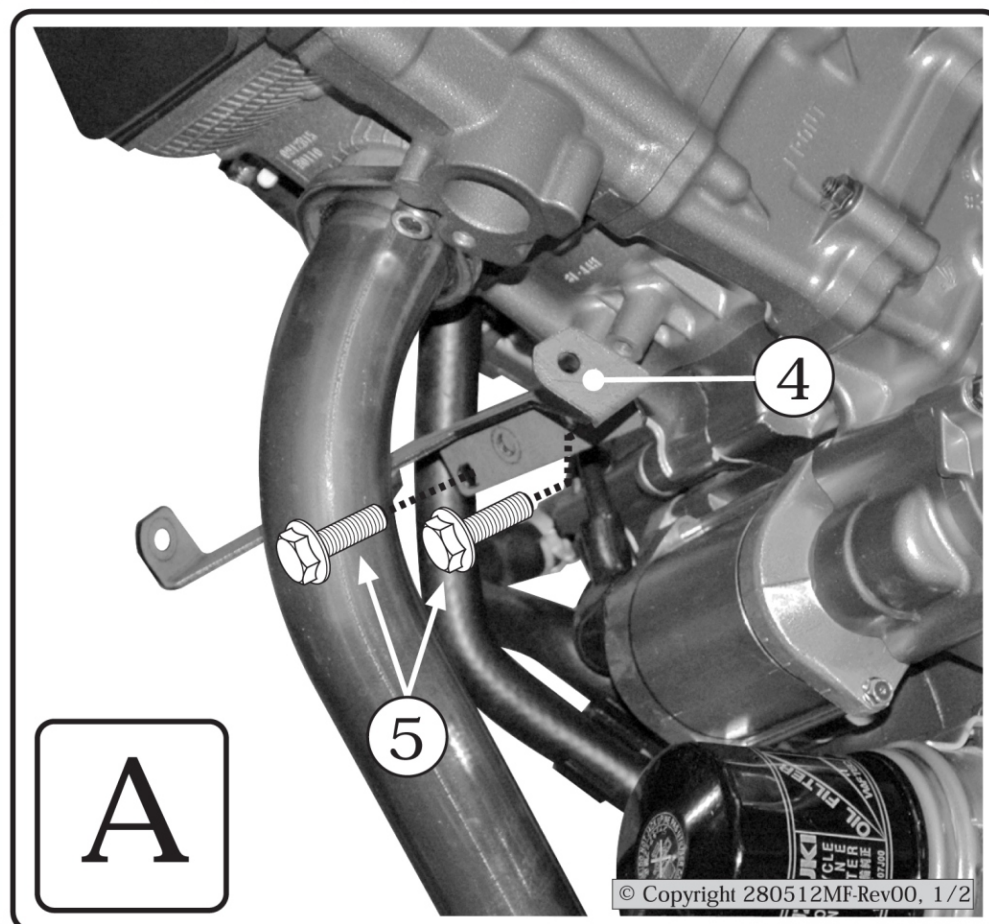
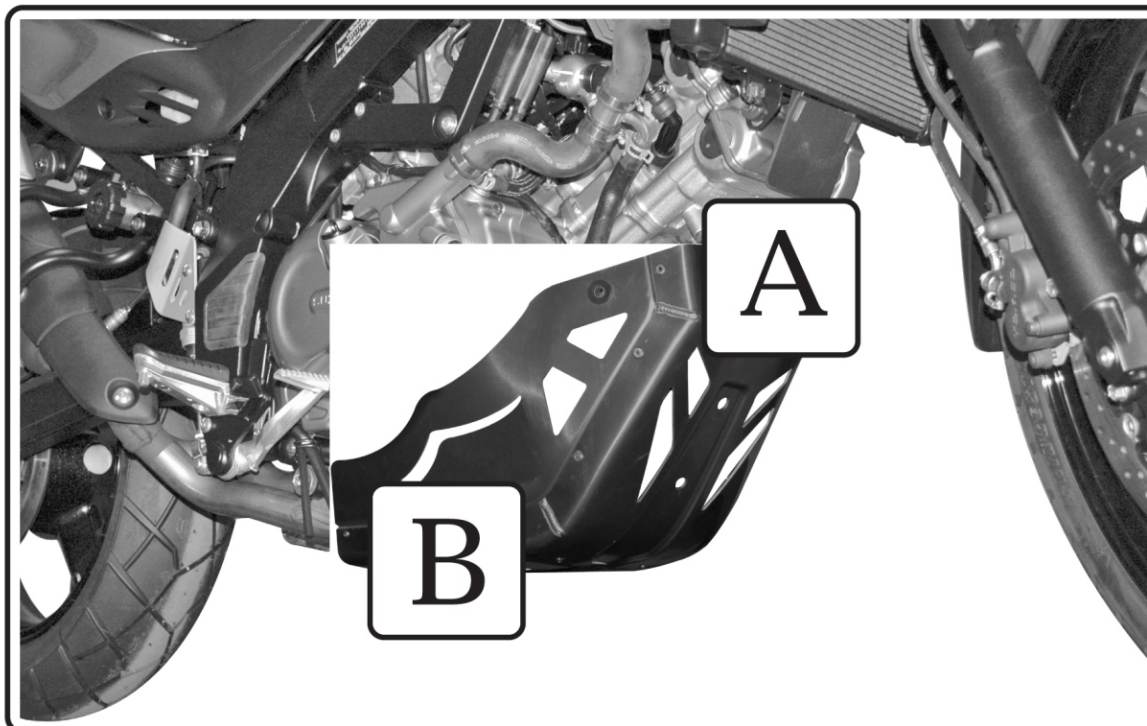

PARACOPPA SPECIFICO - OIL CARTER PROTECTION
 SABOT MOTEUR SPECIFIQUE - SPEZIFISCHER MOTORSCHULTZ - CUBRE CARTER ESPECIFICO

SUZUKI DL650 V-STROM L2

2011 - 2012

ISTRUZIONI DI MONTAGGIO - MOUNTING INSTRUCTIONS
 INSTRUCTIONS DE MONTAGE - BAUANLEITUNG - INSTRUCCIONES DE MONTAJE

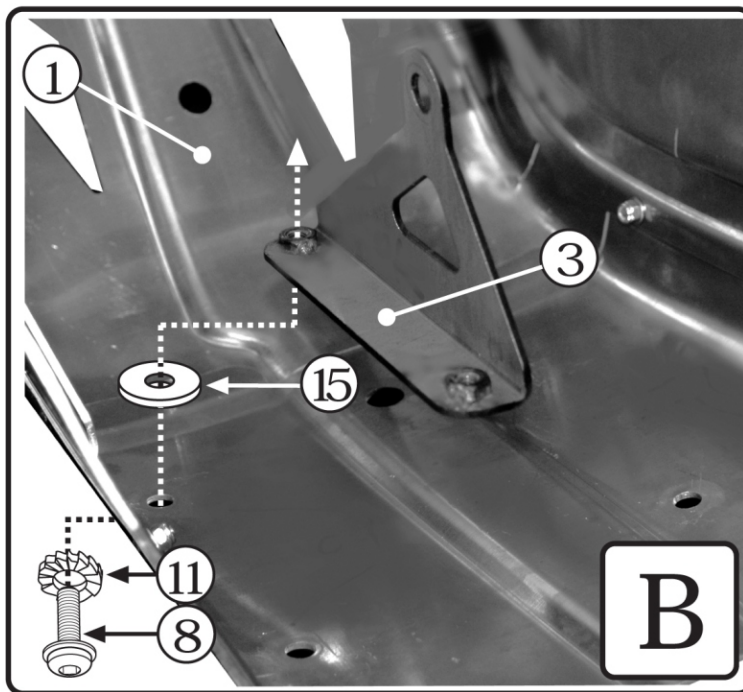

15
O-RING
RONDELLA IN GOMMA
RUBBER WASHER
RONDELE EN CAOUTCHOUC
GUMMI SCHEIBE
ARANDELA DE GOMA
Q.TY n.4

16
Z268
GOMMINO
FAIRLEADER
CHAUMARD
GUMMI
GOMA
Q.TY n.2

