











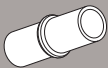

# TN5103 - KN5103

PARAMOTORE SPECIFICO - SPECIFIC ENGINE GUARD - PARE-CARTER SPECIFIQUE SPEZIFISCHER STURZBÜGEL - DEFENSA DE MOTOR ESPECÍFICA







## BMW F800GS (2013)

N°	Descrizione	Caratteristiche	Codice	Quantità	
1	Paramotore - Engine Guard Pare-carter - Sturzbuegel Defensa De Moto	Dx	-	1	
2	Paramotore - Engine Guard Pare-carter - Sturzbuegel Defensa De Moto	Sx	-	1	
3	Piastrina - Little Plate Petite Plaque - Plaettchen Plaqueta	Dx (5mm)	GL1269	1	
4	Piastrina - Little Plate Petite Plaque - Plaettchen Plaqueta	Sx (5mm)	GL1271	1	
5	Supporto - Support Support - Halter - Soporte	-	-	1	
6	Nipples	-	-	1	
7	Vite - Screw Vis - Schraube Tornillo	TEF M8x25	825TEF	3	
8	Vite - Screw Vis - Schraube Tornillo	TEF M8x40	840TEF	1	
9	Vite - Screw Vis - Schraube Tornillo	TEF M8x60	860TEF	2	
10	Vite - Screw Vis - Schraube Tornillo	TEF M8x20	820TEF	2	
11	Vite - Screw Vis - Schraube Tornillo	TBEI M10x20	1020TBEI	2	
12	Vite - Screw Vis - Schraube Tornillo	TCEI M8x35	835TCE	1	
13	Fisher - Expanding Tube Insert Cheville Elastischer - Rohreinsatz Taco	Ø30x25 Rib. 23.7x21 Foro 17.4mm	V695	2	
14	Cono Filettato - Threaded Cone Cone Filete - Kegel Gewinde Cono Roscado	Ø20.4 - Ø18.8 M8	V697	2	

# TN5103 - KN5103

PARAMOTORE SPECIFICO - SPECIFIC ENGINE GUARD - PARE-CARTER SPECIFIQUE SPEZIFISCHER STURZBÜGEL - DEFENSA DE MOTOR ESPECÍFICA

## BMW F800GS (2013)

N°	Descrizione	Caratteristiche	Codice	Quantità	
15	Distanziale - Spacer Entretoise - Distanzstueck Distanciador	Ø18x35 Foro 8.5mm	C18L35F8T	2	
16	Distanziale - Spacer Entretoise - Distanzstueck Distanciador	Ø18x15 Foro 8.5mm	C18L15F8T	1	
17	Distanziale - Spacer Entretoise - Distanzstueck Distanciador	Ø14x20 Foro 8.5mm	V009	1	
18	Rondella - Washer Rondelle - Scheibe Arandela	Ø8mm	8RON	1	
19	Rondella - Washer Rondelle - Scheibe Arandela	Ø10mm	10RON	2	
20	Guarnizione - Gasket Joint D'étanchéité - Dichtung Junta	-	Z2161	2	

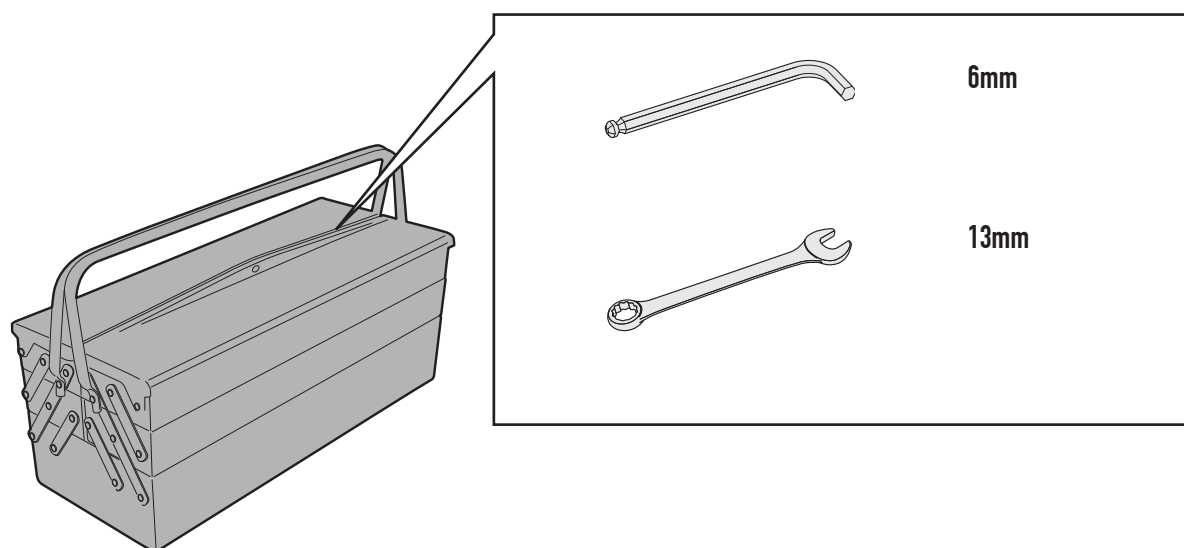

# TN5103 - KN5103

PARAMOTORE SPECIFICO - SPECIFIC ENGINE GUARD - PARE-CARTER SPECIFIQUE SPEZIFISCHER STURZBÜGEL - DEFENSA DE MOTOR ESPECÍFICA

## BMW F800GS (2013)

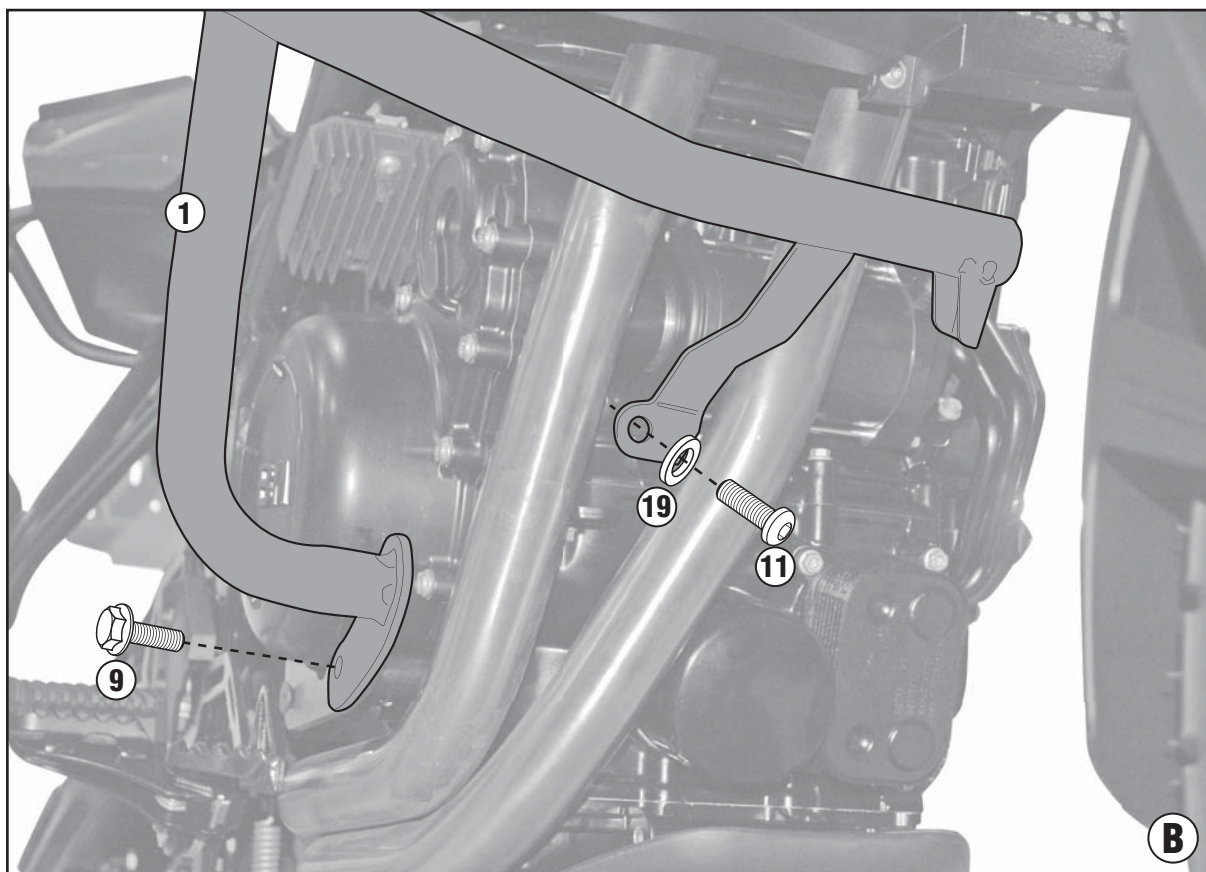
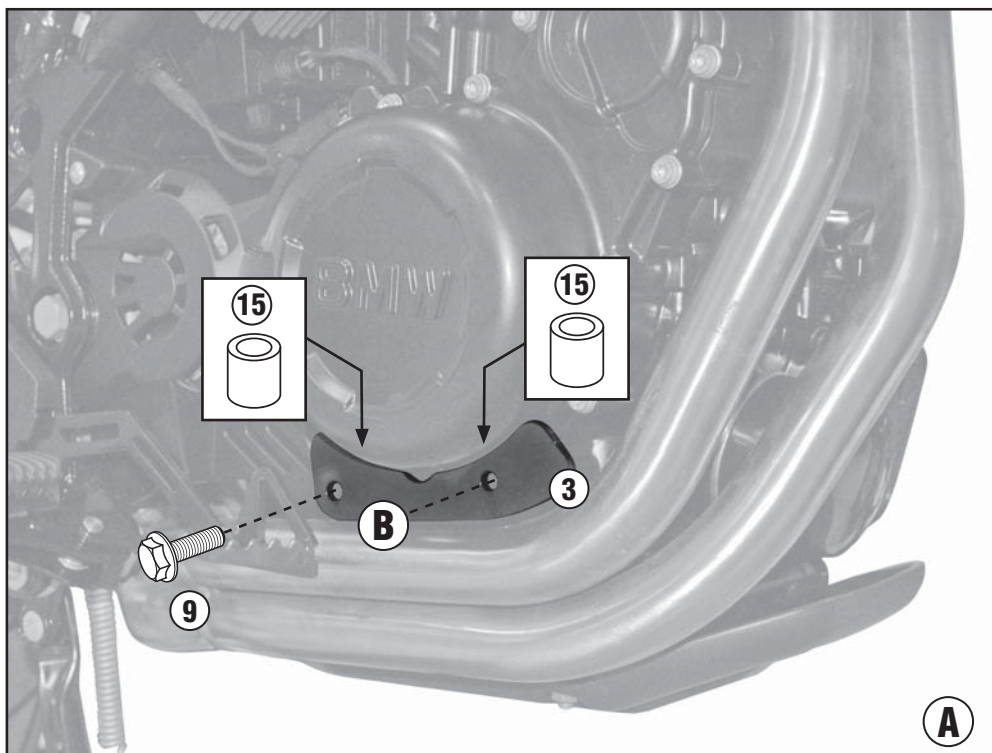

# TN5103 - KN5103

PARAMOTORE SPECIFICO - SPECIFIC ENGINE GUARD - PARE-CARTER SPECIFIQUE SPEZIFISCHER STURZBÜGEL - DEFENSA DE MOTOR ESPECÍFICA

## BMW F800GS (2013)

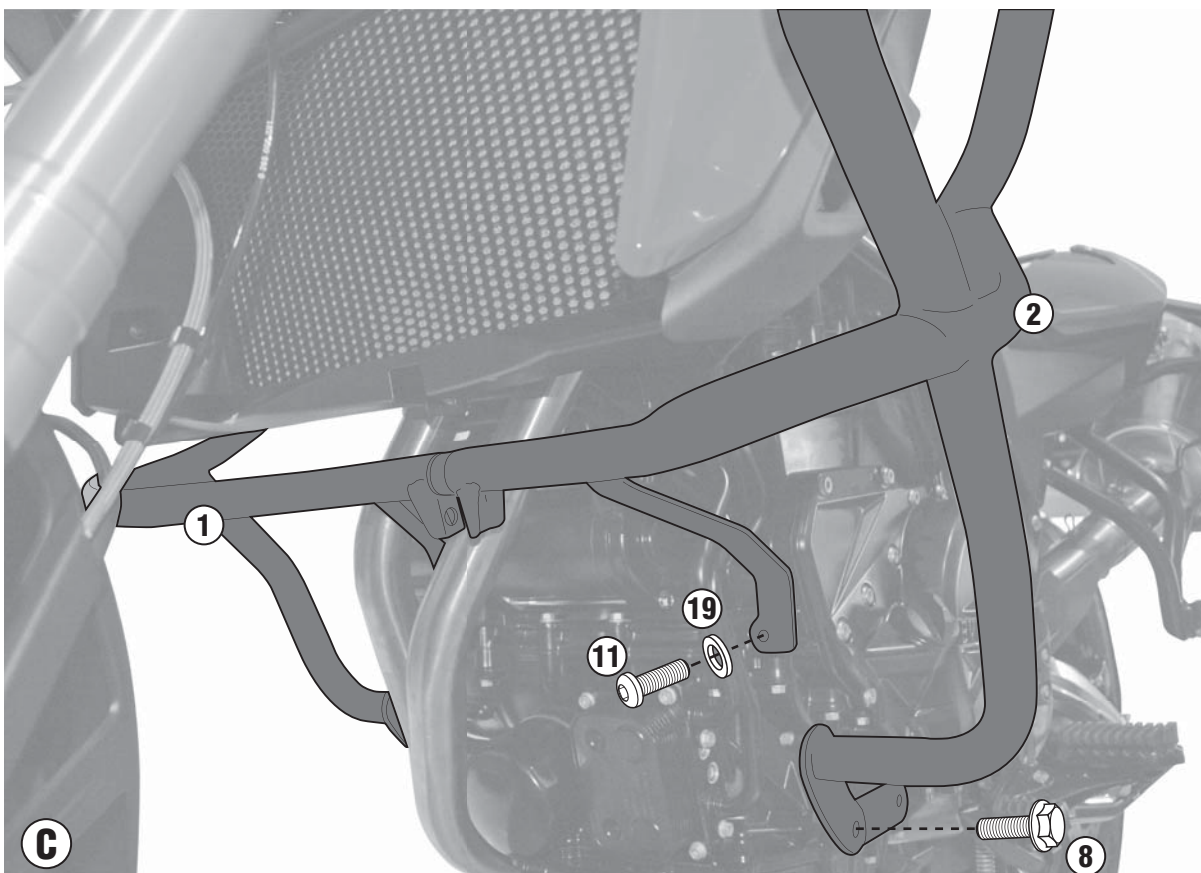
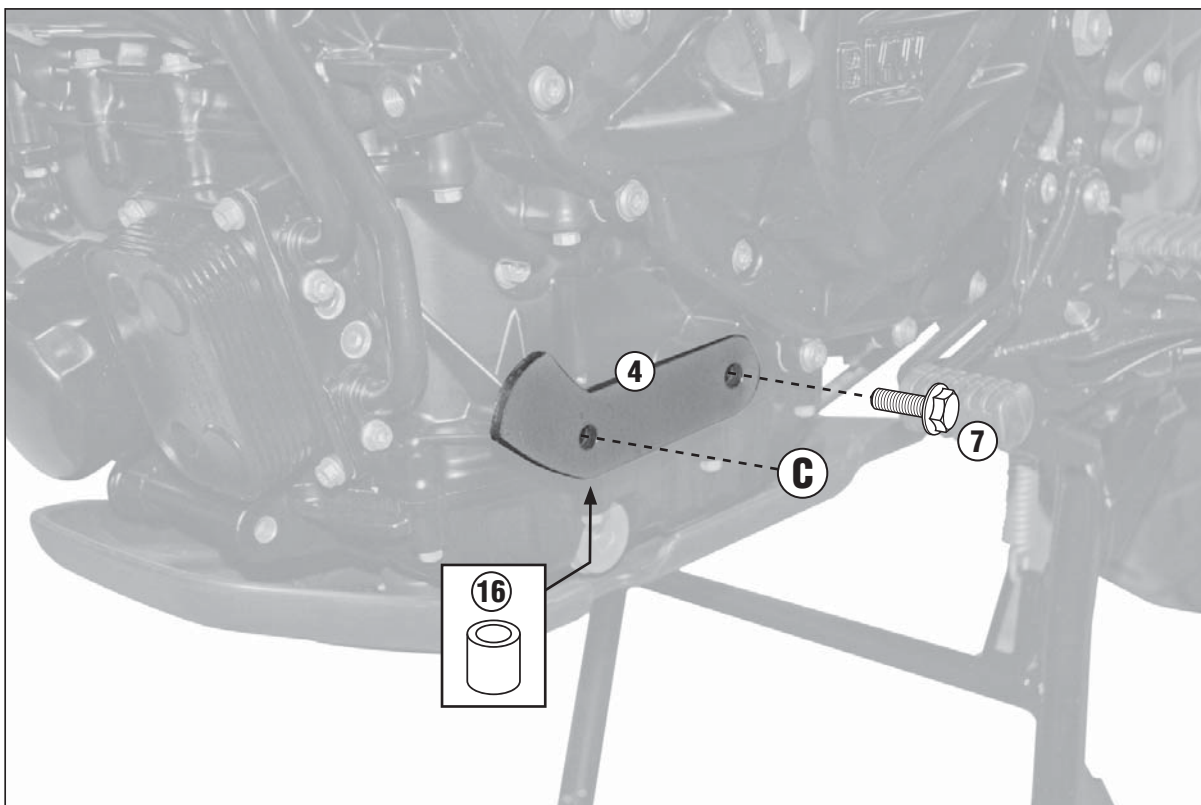

# TN5103 - KN5103

PARAMOTORE SPECIFICO - SPECIFIC ENGINE GUARD - PARE-CARTER SPECIFIQUE SPEZIFISCHER STURZBÜGEL - DEFENSA DE MOTOR ESPECÍFICA

## BMW F800GS (2013)

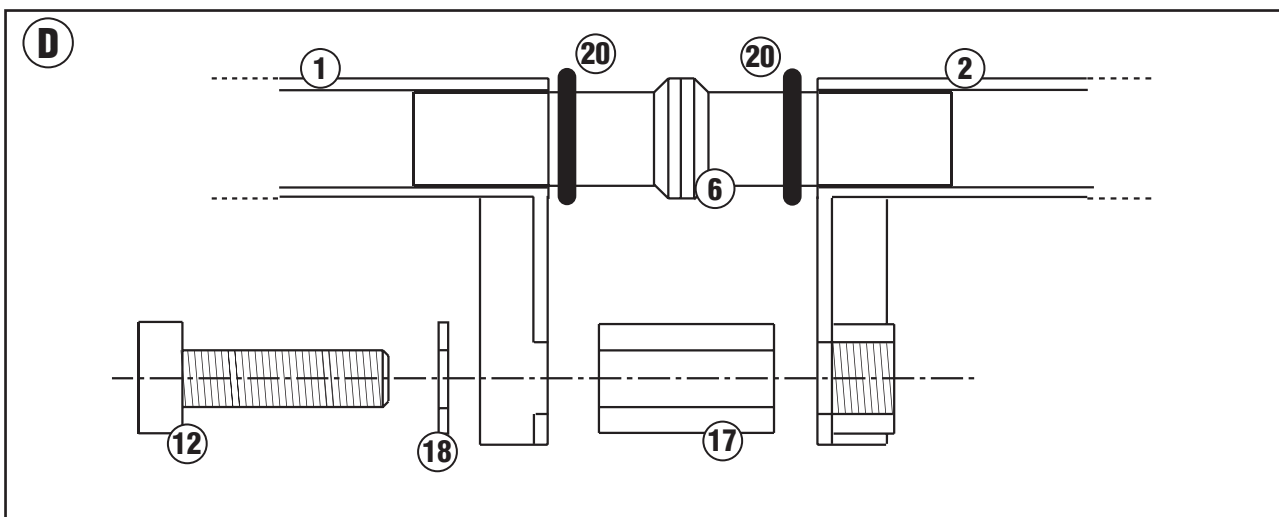
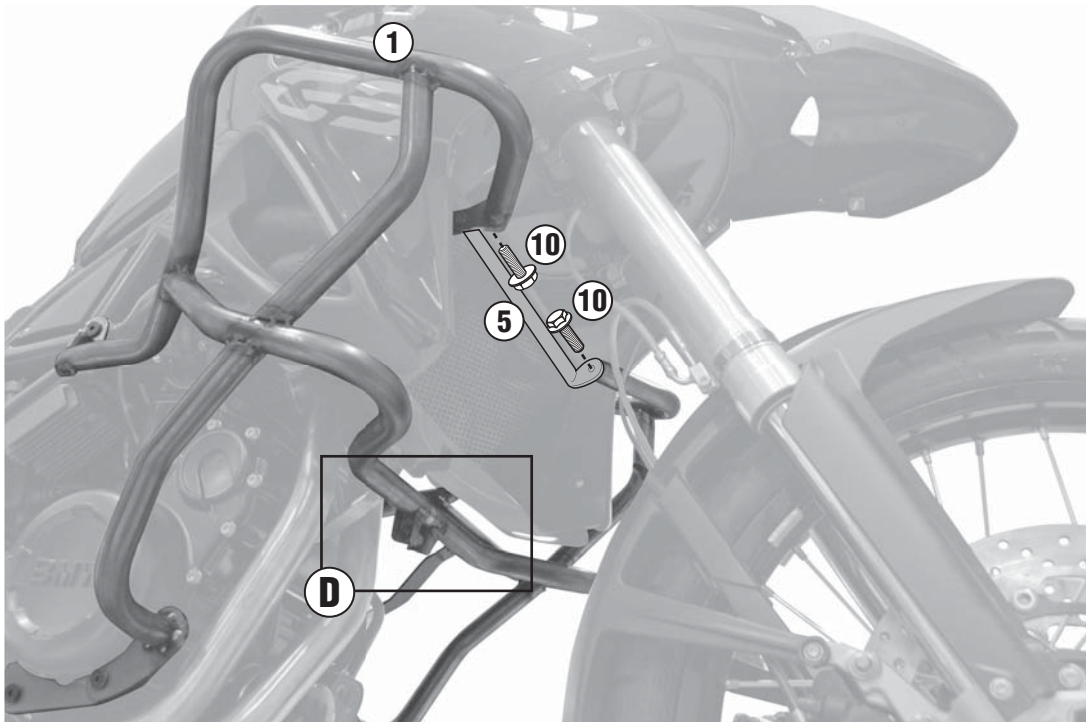
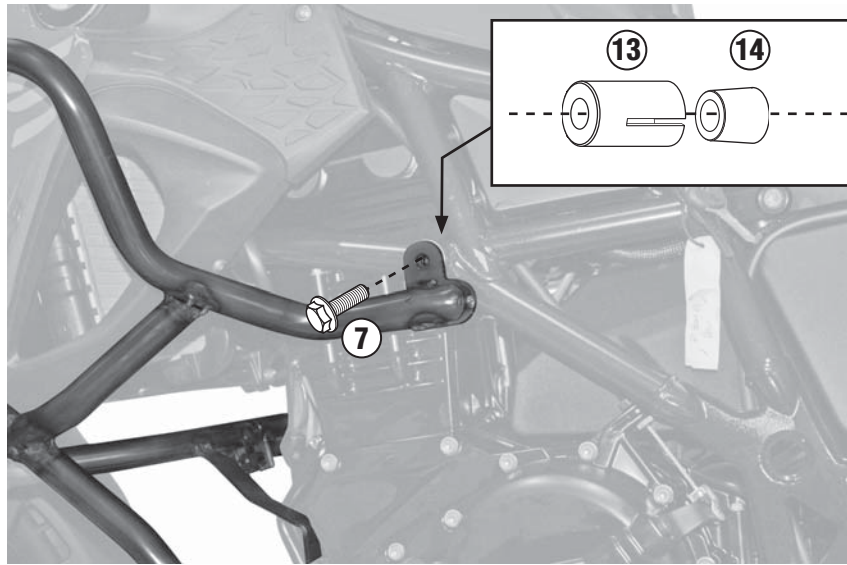

ISTRUZIONI DI MONTAGGIO - MOUNTING INSTRUCTIONS  
INSTRUCTIONS DE MONTAGE - BAUANLEITUNG - INSTRUCCIONES  
DE MONTAJE