

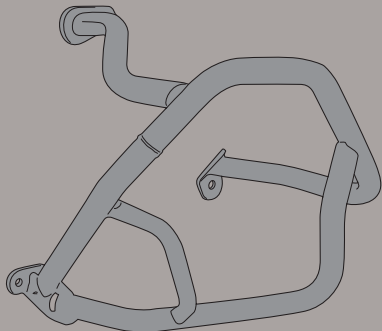

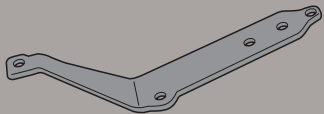
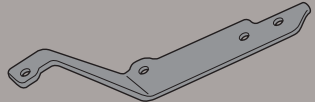

TN51080X - KN51080X

PARAMOTORE SPECIFICO - SPECIFIC ENGINE GUARD - PARE-CARTER SPECIFIQUE - SPEZIFISCHER STURZBÜGEL - DEFENSA DE MOTOR ESPECÍFICA - PARAMOTOR ESPECÍFICO

BMW R1200GS (2013)

N°	Descrizione	Caratteristiche	Codice	Quantità	
1	Paramotore - Engine Guard Pare-carter - Sturzbuegel Defensa De Moto - Paramotor	-	-	2 (Dx;Sx)	
2	Supporto - Support - Support Halterung - Soporte - Apoio	Sp. 5mm (Dx)	GL2413	1	
3	Supporto - Support - Support Halterung - Soporte - Apoio	Sp. 5mm (Sx)	GL2414	1	
4	Vite - Screw Vis - Schraube Tornillo - Parafuso	TCEI M10x50 INOX	1050TCEX	4	
5	Vite - Screw Vis - Schraube Tornillo - Parafuso	TECEI M10x30 z	1030TCEX	2	
6	Vite - Screw Vis - Schraube Tornillo - Parafuso	TCEI M8x25 INOX	825TCEX	6	
7	Vite - Screw Vis - Schraube Tornillo - Parafuso	TCEI M8x20 INOX	820TCEX	2	
8	Fisher - Expanding Tube Insert Cheville - Elastischer Rohreinsatz Taco - Espaçador	Ø33x22 Foro 28mm	LT0979	2	
9	Distanziale - Spacer Entretoise - Distanzstueck Distanciador - Espaçador	Ø29.5/Ø26.5 Foro M10 passo 1,25	V863	2	

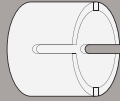
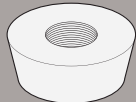
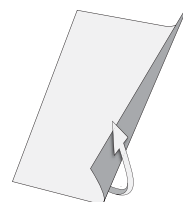

TN51080X - KN51080X

PARAMOTORE SPECIFICO - SPECIFIC ENGINE GUARD - PARE-CARTER SPECIFIQUE - SPEZIFISCHER STURZBÜGEL - DEFENSA DE MOTOR ESPECÍFICA - PARAMOTOR ESPECÍFICO

BMW R1200GS (2013)

N°	Descrizione	Caratteristiche	Codice	Quantità	
10	Rondella - Washer Rondelle - Scheibe Arandela - Arruela	Ø10 INOX	10RONX	6	
11	Rondella - Washer Rondelle - Scheibe Arandela - Arruela	Ø8 INOX	8RONX	8	
12	Dado - Bolt - Ecrou Mutter - Tuerca - Porca	Dado Auto Bloccante Flangiato M8 INOX	8DADIAFLNX	6	

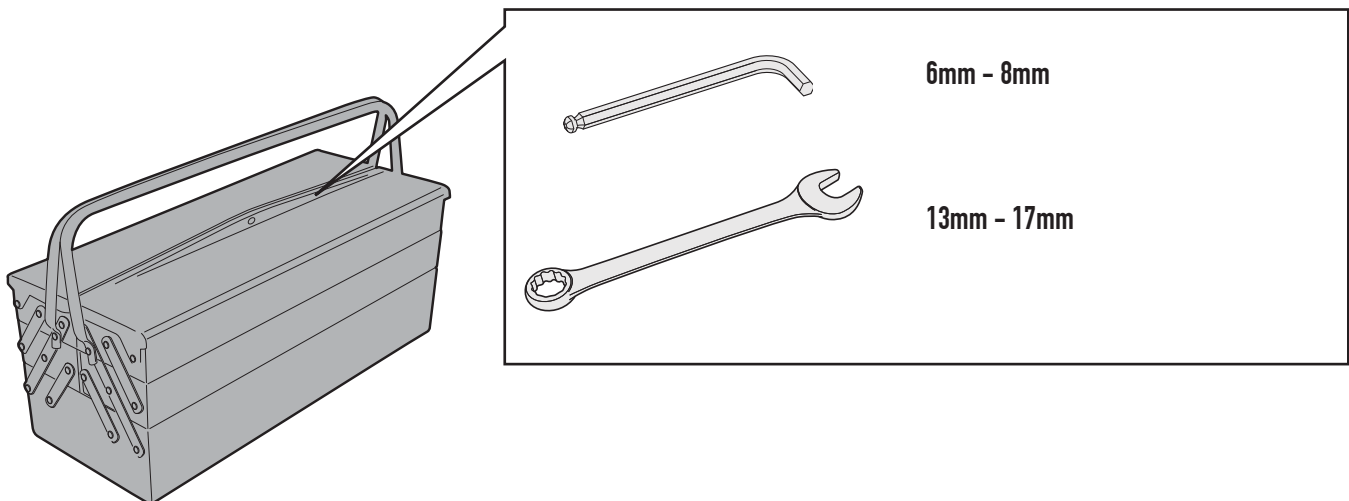

TN51080X - KN51080X

PARAMOTORE SPECIFICO - SPECIFIC ENGINE GUARD - PARE-CARTER SPECIFIQUE - SPEZIFISCHER STURZBÜGEL - DEFENSA DE MOTOR ESPECÍFICA - PARAMOTOR ESPECÍFICO

BMW R1200GS (2013)

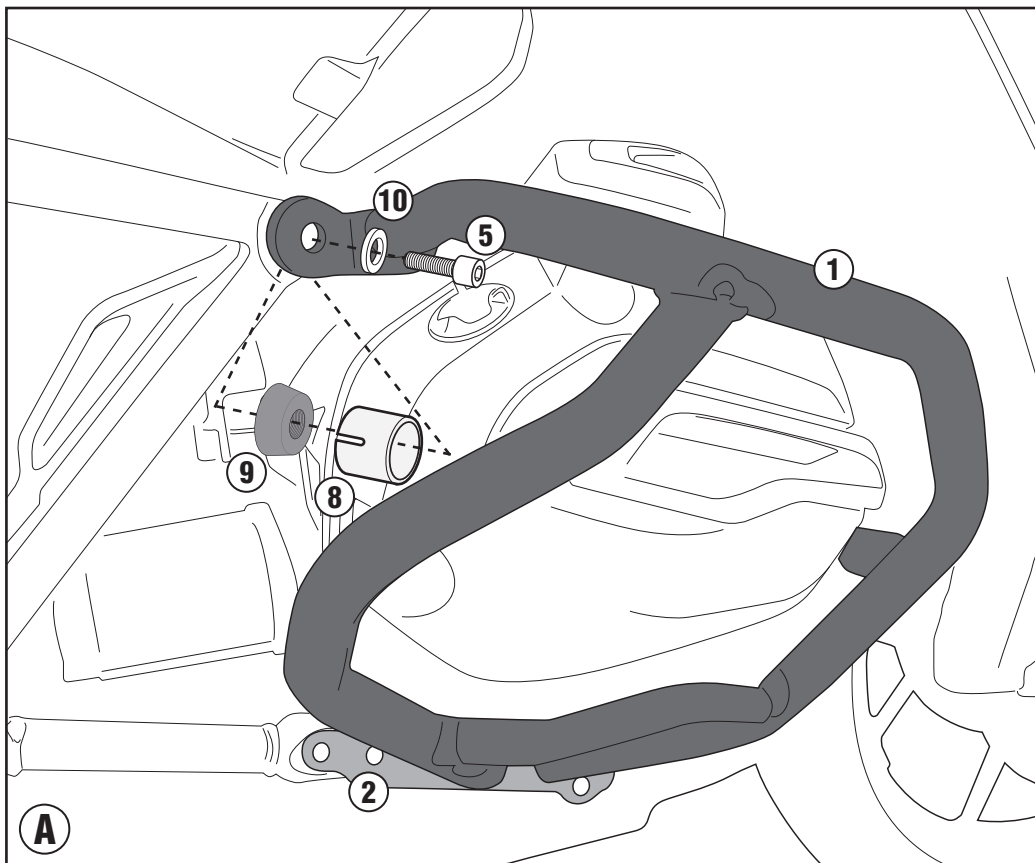
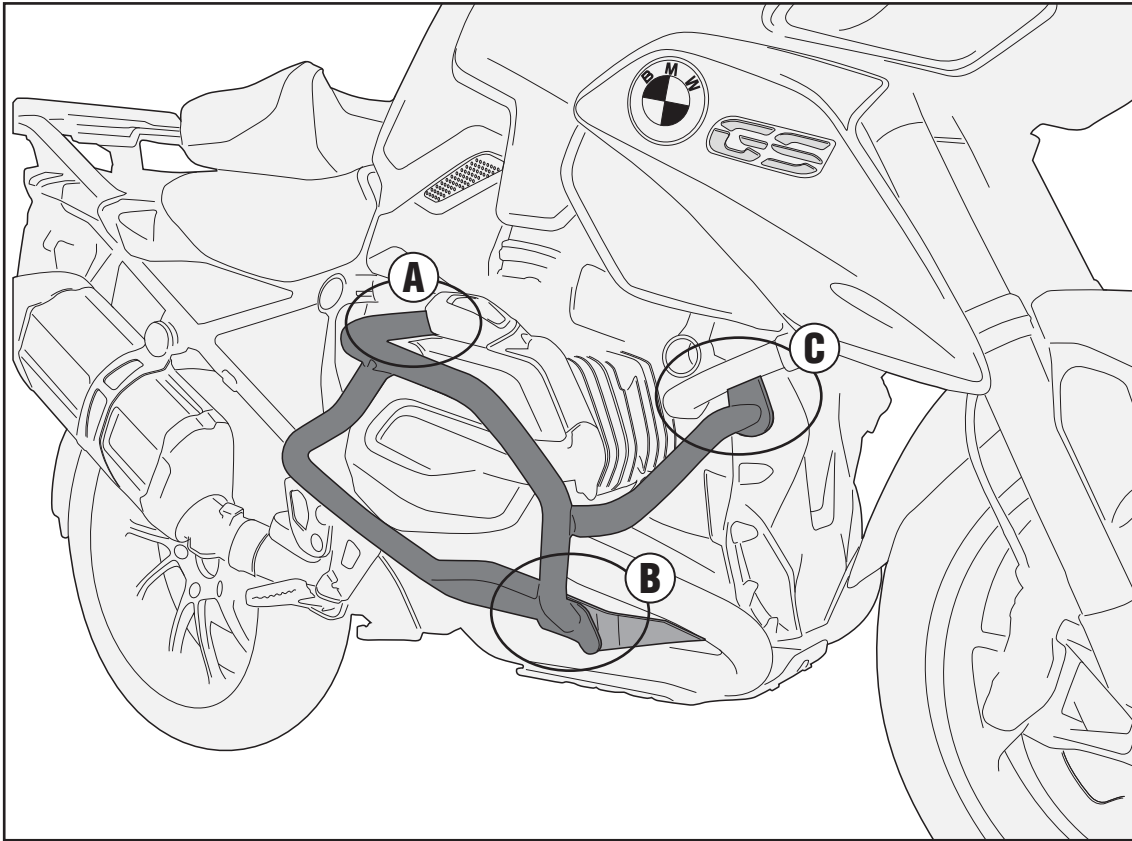

ISTRUZIONI DI MONTAGGIO - MOUNTING INSTRUCTIONS
INSTRUCTIONS DE MONTAGE - BAUANLEITUNG
INSTRUCCIONES DE MONTAJE - INSTRUÇÕES DE MONTAGEM

TN51080X - KN51080X

PARAMOTORE SPECIFICO - SPECIFIC ENGINE GUARD - PARE-CARTER SPECIFIQUE - SPEZIFISCHER STURZBÜGEL - DEFENSA DE MOTOR ESPECÍFICA - PARAMOTOR ESPECÍFICO

BMW R1200GS (2013)

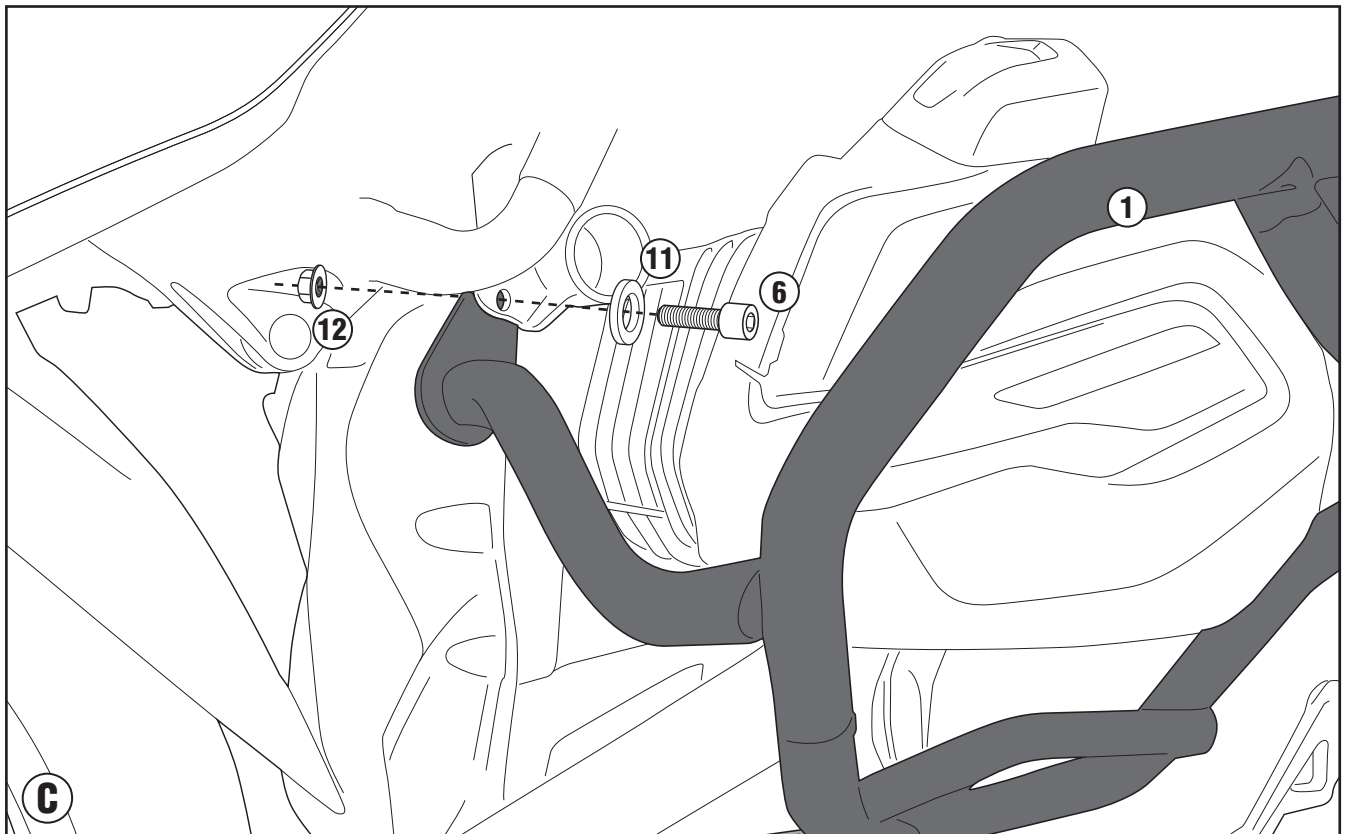
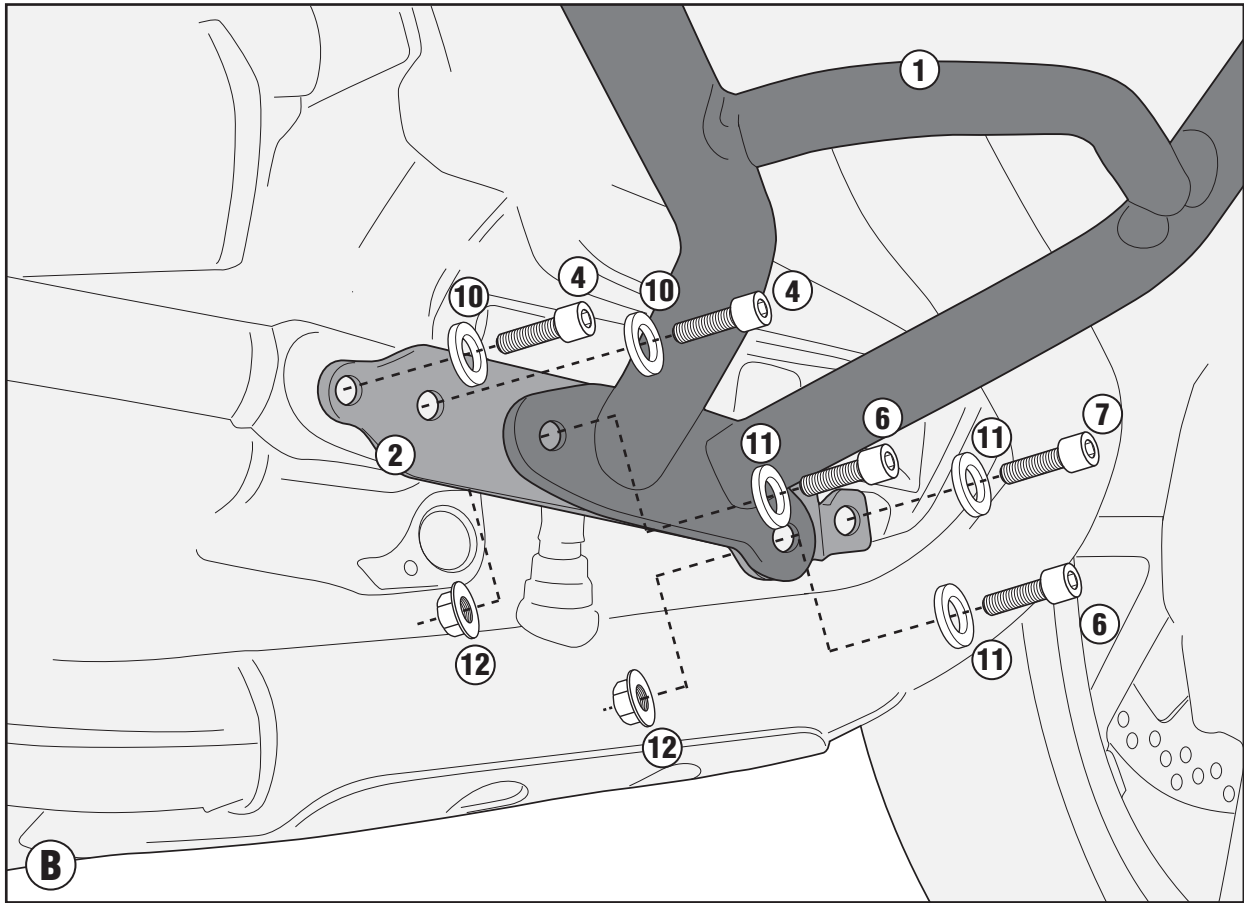

ISTRUZIONI DI MONTAGGIO - MOUNTING INSTRUCTIONS
INSTRUCTIONS DE MONTAGE - BAUANLEITUNG
INSTRUCCIONES DE MONTAJE - INSTRUÇÕES DE MONTAGEM