

Item number: **SBL.01.971.10000/B**

Revision: **00** · Date: **02 - 2023**

## Crash bar

 ~ 1 h.

EASY     DIFFICULT

**ENGLISH** · Thank you for choosing this premium product from SW-MOTECH. Visit our online shop for more information (e.g. model assignments). Required documents (e.g. general certification) are available there for you to download. **Please read and understand all the instructions, safety information and warnings in these mounting instructions before mounting and using the product in order to avoid injury and damage. Keep these mounting instructions for reference.**

This product was developed for vehicles in factory condition. Compatibility with original accessories or accessories from other manufacturers cannot be guaranteed.

These mounting instructions have been prepared to the best of our current knowledge. No legal claims relating to accuracy can be made. Errors and omissions excepted. We reserve the right to make technical and design changes. The copyright is held by SW-MOTECH.

### SAFETY WARNING SYMBOL

 This warning symbol is used in these mounting instructions to warn of deadly dangers, injuries or other hazards. The words **DANGER**, **WARNING** or **CAUTION** are used as part of this warning symbol to convey important safety messages and information relating to the installation and use of this product. These words, together with the safety warning symbol, mean:

 **DANGER:** Indicates a hazardous situation which, if not avoided, will result in death or serious injury!

 **WARNING:** Indicates a hazardous situation which, if not avoided, may result in death or serious injury!

 **CAUTION:** Indicates a hazardous situation which, if not avoided, may result in minor or moderate injury!

 **NOTE:** Important information, but not relating to a risk of death or injury (property damage only)!

### GENERAL INFORMATION

 **WARNING:** Assembly and/or maintenance of this product requires advanced technical skills, appropriate tools and a good understanding of tool usage and torque specifications. For your own safety, SW-MOTECH recommends that assembly and/or maintenance is carried out by a qualified and certified two-wheeler workshop.

 **WARNING:** If you decide to install this product yourself, read the installation instructions carefully and fully before installation and use, and follow all instructions to avoid serious or fatal injuries. Also observe all relevant information in the vehicle manual when mounting and using the product. **IF YOU DO NOT UNDERSTAND ANY PART OF THESE MOUNTING INSTRUCTIONS OR REQUIRE EXPLANATION OF ANY INSTRUCTION, DO NOT ATTEMPT TO INSTALL THIS PRODUCT WITHOUT ASKING SW-MOTECH FOR HELP!**

**PREPARATION:** Read the mounting instructions carefully and make sure that all parts on the parts list are available.

 **CAUTION:** Ensure that your vehicle is standing securely. Switch off the engine and remove the ignition key. Allow the engine/exhaust to cool down, if necessary. Disconnect the battery when working on the electrics. Only use suitable tools, and always wear protective goggles and gloves during assembly and maintenance. Have a second person help you during assembly and maintenance.

**ASSEMBLY:** All parts and connections removed from the vehicle must be reinstalled according to the vehicle manufacturer's specifications or replaced with parts and hardware supplied by SW-MOTECH.

 **WARNING:** Secure all threads with a medium-strength liquid threadlocker, unless otherwise specified.

 **DANGER:** Tightening torques not defined by SW-MOTECH must be obtained from the vehicle manufacturer or a certified motorbike workshop.



**FUNCTIONALITY CHECK:** After assembly, make sure that no moving parts are obstructed and that the function of the vehicle is not impeded. Cables and hoses must not be chafed and/or pinched.

 **WARNING:** Carry out a comprehensive functionality check before you start to drive. Check the tightening torque of all connections and the tight fit of the product after the first 50 km and then at regular intervals. Mounted accessories can change the handling and stability of the vehicle.



SW-MOTECH GmbH & Co. KG  
Ernteweg 7-10  
35282 Rauschenberg  
Germany



 [info@sw-motech.com](mailto:info@sw-motech.com)  
 [www.sw-motech.com](http://www.sw-motech.com)

## LEGEND OVERVIEW - READ AND KEEP MOUNTING INSTRUCTIONS!



Take note of the symbols and what they mean in the ASSEMBLY section. If the term OEM appears in the ASSEMBLY section, the vehicle manufacturer's specifications must be observed and applied.



If you have any questions, please don't hesitate to contact our Customer Service team or our distributors. You can find our telephone number and a list of our distributors in our online shop:

**[www.sw-motech.com](http://www.sw-motech.com)**



**Do not use thread lock:** Indicates that no liquid thread lock should be used at this point.



**Tighten/note the tightening torque information:**

Indicates the tightening torque of a part specified by SW-MOTECH or the vehicle manufacturer (OEM).



**Use thread locker:** Indicates that a thread must be coated with liquid thread locker. H (HIGH): high strength; M (MEDIUM): medium strength; L (LOW): low strength.

**PARTS LIST - READ AND KEEP MOUNTING INSTRUCTIONS!**

**2**

**1**



SBL.01.971.001.11

 **2/2**

**2**



M10 x 80; DIN 912

SC.ST.10.080.01.912.088

 **2/4**

**3**



∅ 10; DIN 125

US.ST.105.01.125

 **2/4**

**4**



∅ 25 / ∅ 10.5 / h 4

DB.ST.0250.0105.0040.01

 **2/2**

**5**



M10; DIN 6927

MU.ST.10.01.6927.08

 **2/4**

**3**

**6**



SBL.01.971.901.01.11

 **1/1**

**7**



SBL.01.971.902.01.11

 **1/1**

**8**



M10 x 80; DIN 912

SC.ST.10.080.01.912.088

 **2/4**

**9**



∅ 10; DIN 125

US.ST.105.01.125

 **2/4**

**10**



M10; DIN 6927

MU.ST.10.01.6927.08

 **2/4**

**11**



M12 x 110; DIN 912

SC.ST.12.110.01.912F.088

 **2/2**

**12**



∅ 13; DIN 125

US.ST.130.01.125

 **2/2**

**13**



∅ 25 / ∅ 12.5 / h 57

DB.ST.0250.0125.0570.02

 **2/2**

**14**



KES.RD.260.0270.02.GL

 **2/2**

**4**

**15**



M8 x 25; DIN 933

SC.ST.08.025.01.933.088

 **2/2**

**16**



∅ 8.4; DIN 125

US.ST.084.01.125

 **2/2**

**17**



M8; DIN 6927

MU.ST.08.01.6927.08

 **2/2**

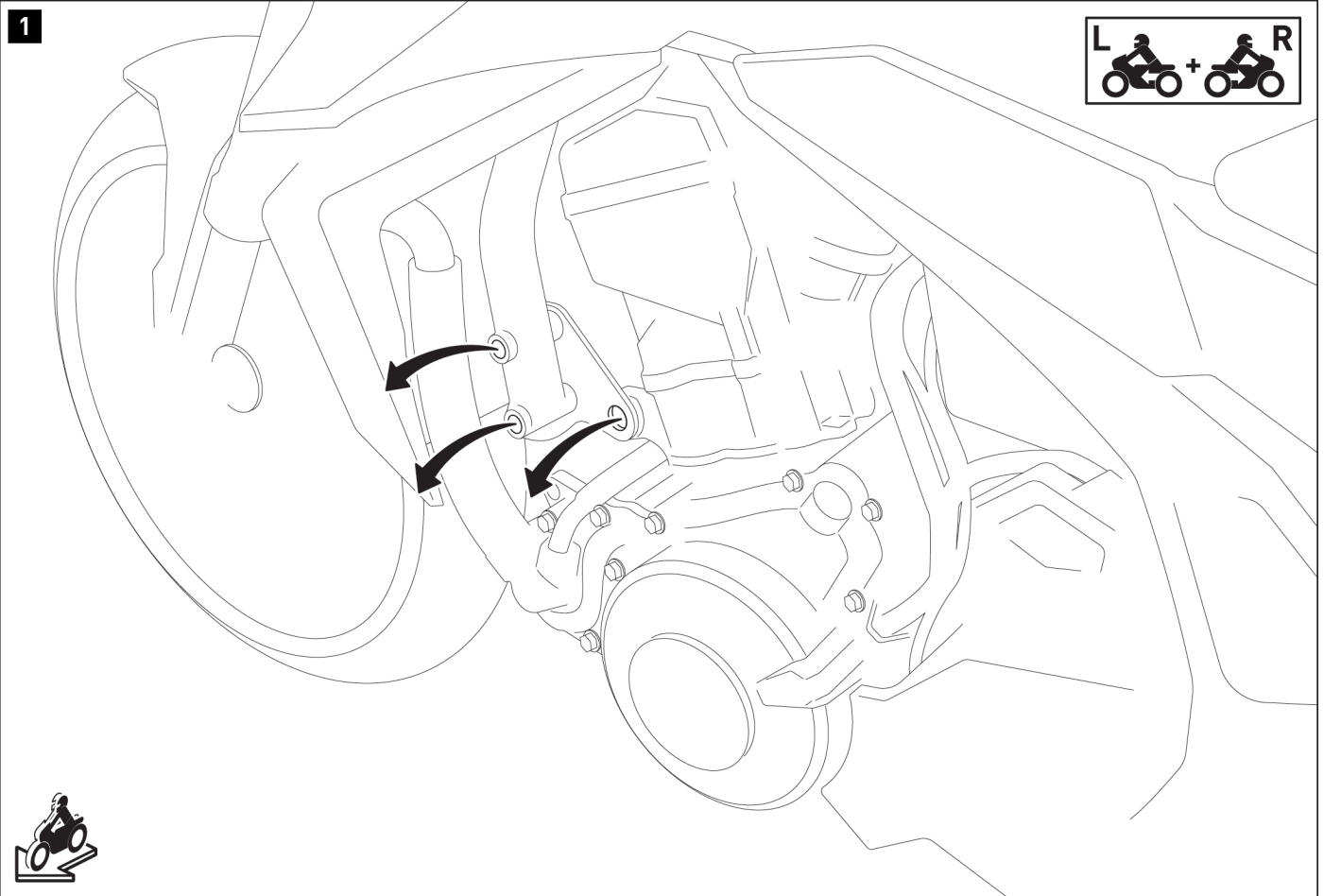

- ▲ **WARNING: Always wear eye and hand protection!**
- ▲ **WARNING: Always use the proper tools!**

- ▲ **WARNING: Do not start fitting the right-hand crash bar until you have finished fitting the left crash bar!**
- ▲ **WARNING: the engine should be supported using an appropriate jack!**

Remove the screws from the mounting points shown.

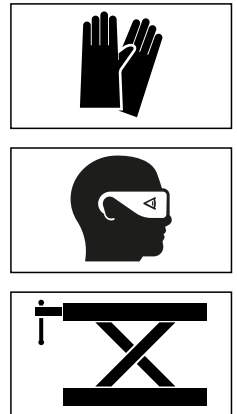

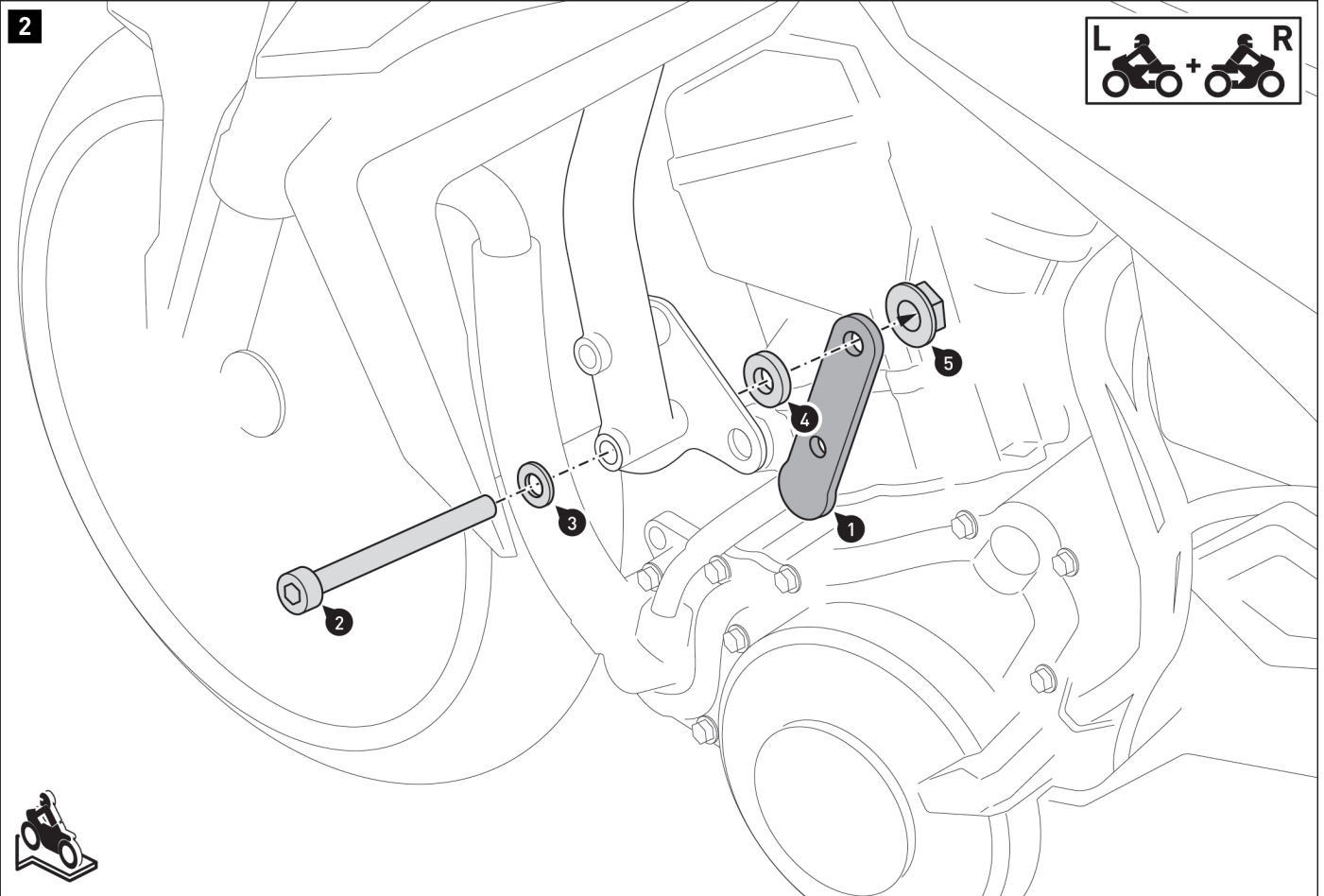

Screw the mounting bracket (1) to the vehicle.  
Do not tighten the screw yet.

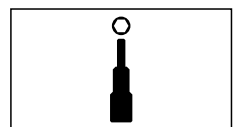
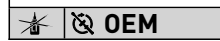
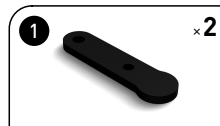

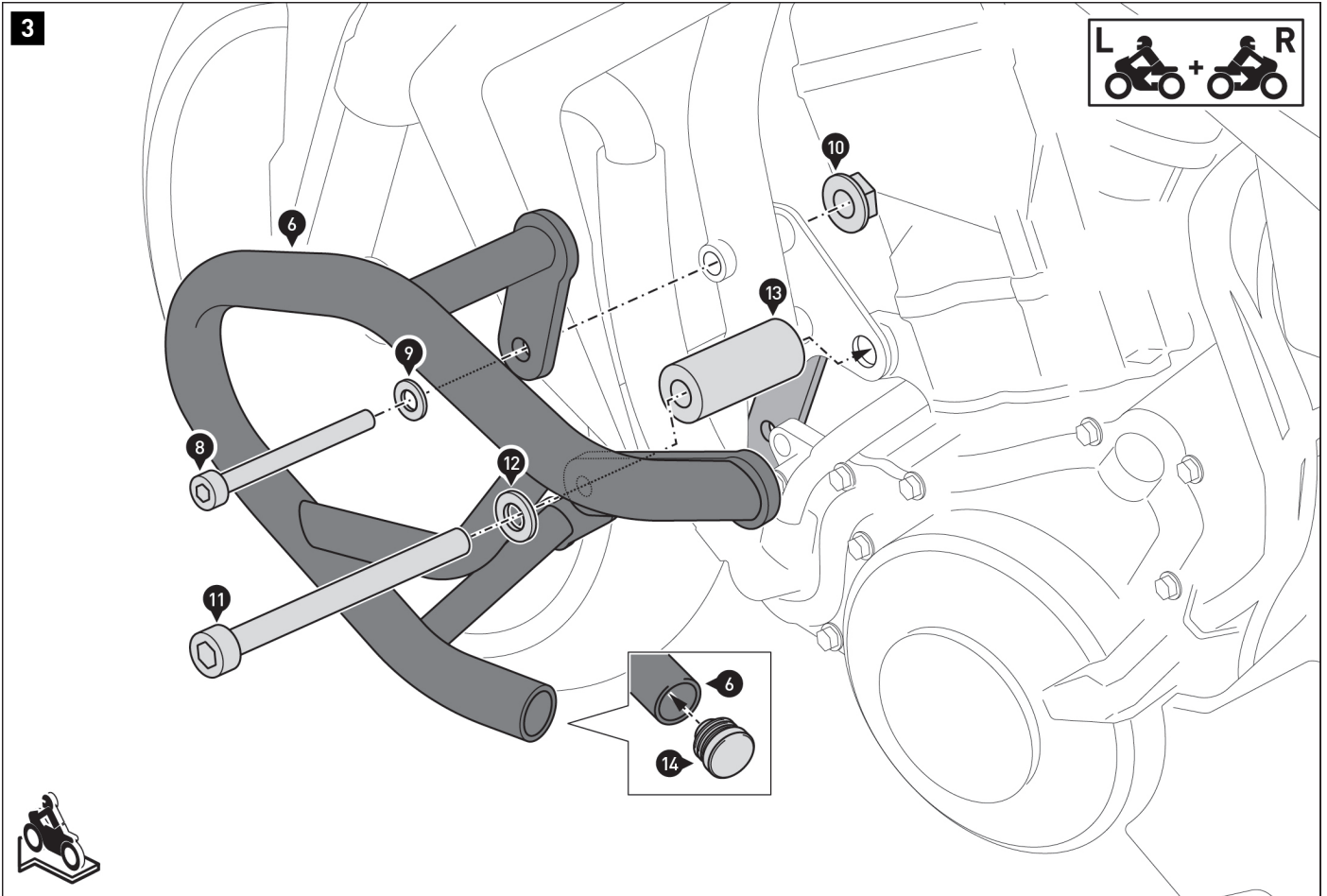

Insert the plastic plugs (14) into the openings of crash bars (6) and (7).

Screw the left crash bar (6) to the vehicle.

**▲ WARNING: Use liquid thread locker for screw (11)!**  
Do not tighten the screws yet.

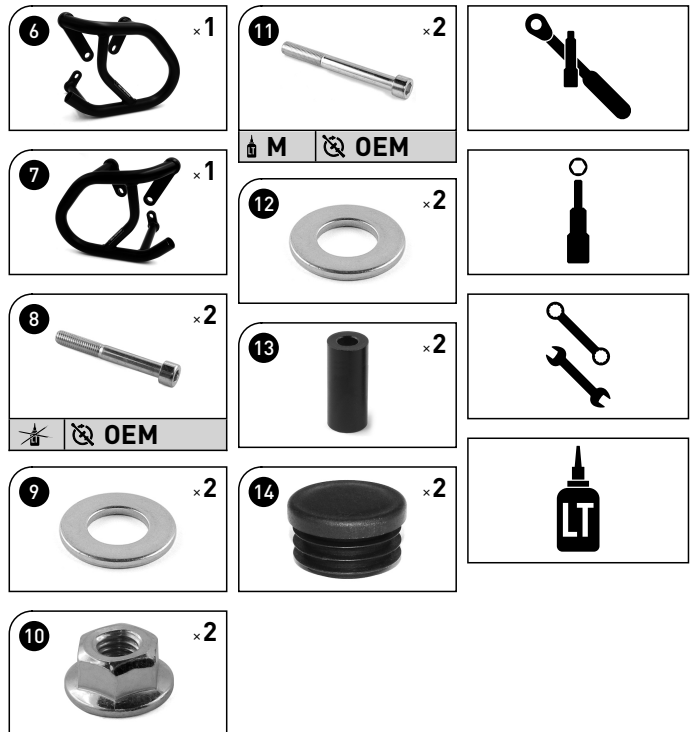

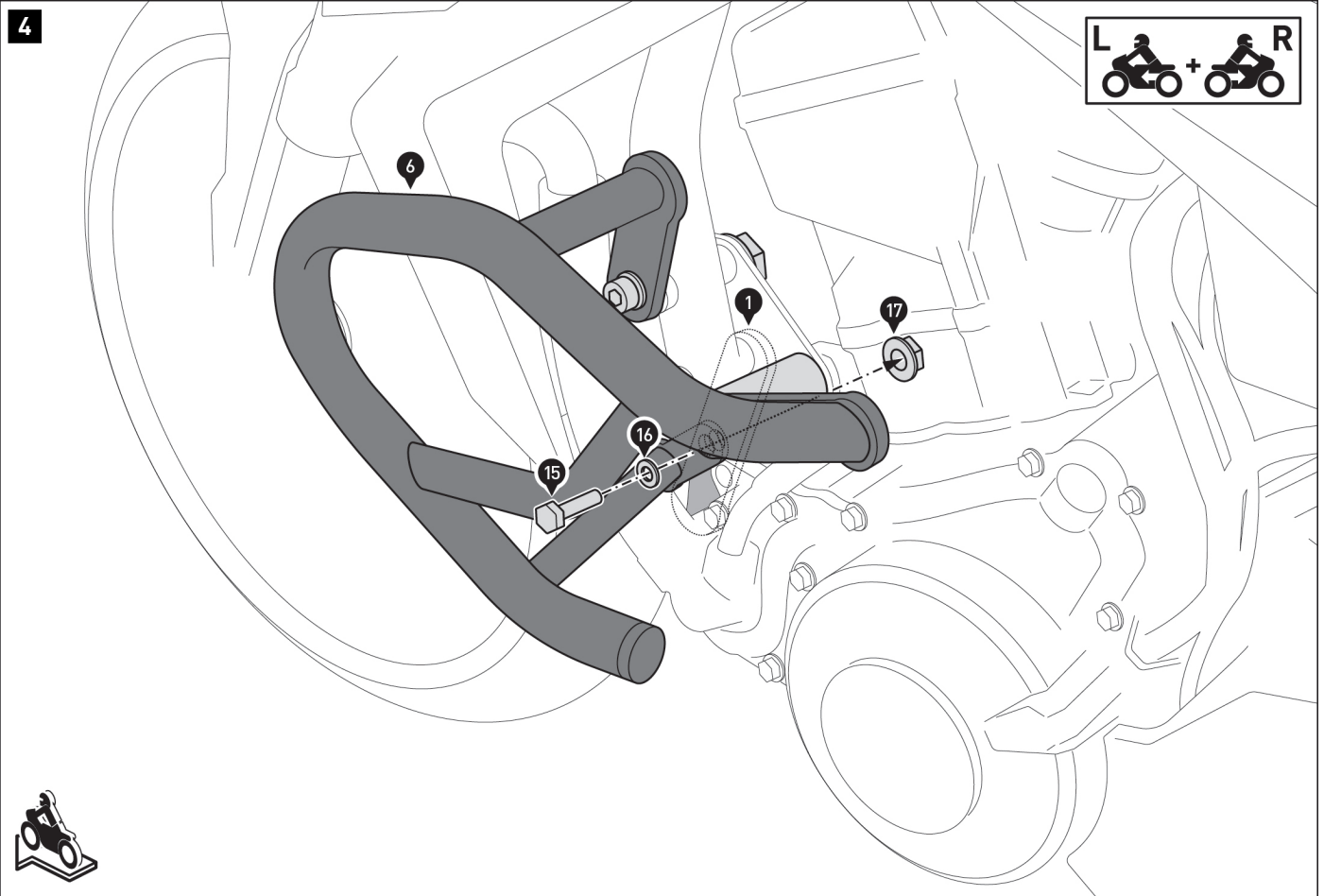

Screw the left crash bar (6) to the mounting bracket (1) and to the vehicle. When all components have been loosely attached, tighten screws (15) as specified in the mounting instructions. Tighten screws (2), (8) and (11) according to the manufacturer's instructions.

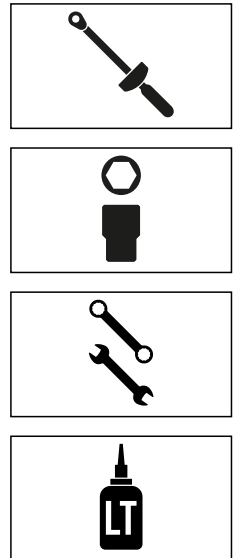

**PRODUCT-SPECIFIC NOTES**

**⚠ WARNING: This product may inhibit cornering and ground clearance in cases of extreme inclination!**

**⚠ NOTE:** Please observe the country-specific regulations for the registration/operation of your vehicle or any applicable TÜV regulations. After installation, parts subject to registration should be entered in the vehicle documents by your test center.