

# ANBAUANLEITUNG

mounting instructions • instructions de montage • instrucciones de montaje • istruzioni di montaggio

## **KFT.22.995.60100/B**

beinhaltet • contains • contient • contiene • contiene

KFT.22.995.30001/B

KFT.00.152.35200

BC.HTA.00.675.12000/B

QLS.00.095.10001/B

Item number: KFT.22.995.30001/B

Revision: 00 · Date: 11 - 2022

## PRO side carrier

 ~ 1 h.EASY     DIFFICULT

**ENGLISH** Thank you for choosing this premium product from SW-MOTECH. Visit our online shop for more information (e.g. model assignments). Required documents (e.g. national type approval) are available there for you to download.

Please read and understand all the instructions, safety information and warnings in these mounting instructions before mounting and using the product in order to avoid injury and damage. Keep these mounting instructions for reference.

This product was developed for vehicles in factory condition. Compatibility with original accessories or accessories from other manufacturers cannot be guaranteed.

These mounting instructions have been prepared to the best of our current knowledge. No legal claims relating to accuracy can be made. Errors and omissions excepted. We reserve the right to make technical and design changes. The copyright is held by SW-MOTECH.

## SAFETY WARNING SYMBOL

 This warning symbol is used in these mounting instructions to warn of deadly dangers, injuries or other hazards. The words DANGER, WARNING or CAUTION are used as part of this warning symbol to convey important safety messages and information relating to the installation and use of this product. These words, together with the safety warning symbol, mean:

 **DANGER:** Indicates a hazardous situation which, if not avoided, will result in death or serious injury!

 **WARNING:** Indicates a hazardous situation which, if not avoided, may result in death or serious injury!

 **CAUTION:** Indicates a hazardous situation which, if not avoided, may result in minor or moderate injury!

 **NOTE:** Important information, but not relating to a risk of death or injury (property damage only)!

## GENERAL INFORMATION

 **WARNING:** Assembly and/or maintenance of this product requires advanced technical skill, appropriate tools, and a good understanding of tool usage and torque specifications. For your own safety, SW-MOTECH recommends having the assembly and/or maintenance carried out by a qualified and certified motorcycle workshop.

 **WARNING:** If you do choose to assemble this product yourself, carefully and fully read the mounting instructions before assembly and use, and follow all instructions to avoid serious injury or death. Also observe all relevant information in the vehicle manual when mounting or using the product. IF YOU DO NOT UNDERSTAND ANY PART OF THESE MOUNTING INSTRUCTIONS OR NEED AN EXPLANATION AS TO A SPECIFIC INSTRUCTION, DO NOT ATTEMPT TO INSTALL THIS PRODUCT WITHOUT CONSULTING SW-MOTECH FOR ASSISTANCE!

**PREPARATION:** Read the mounting instructions carefully and make sure that all parts on the parts list are available.

 **CAUTION:** Ensure that your vehicle is standing securely. Switch off the engine and remove the ignition key. Allow the engine/exhaust to cool down if necessary. Disconnect the battery when working on the electrical system. Only use proper tools and always wear safety goggles and gloves during assembly and maintenance. Have a second person help you with assembly and maintenance.

**ASSEMBLY:** All parts and connections removed from the vehicle must be reinstalled according to the vehicle manufacturer's specifications or replaced with parts and hardware supplied by SW-MOTECH.

 **WARNING:** Secure all threads with a medium-strength liquid threadlocker, unless otherwise specified.

 **DANGER:** Tightening torques not defined by SW-MOTECH must be obtained from the vehicle manufacturer or a certified motorbike workshop.



**FUNCTIONAL CHECK:** After mounting the product, ensure that no moving parts are obstructed and that the function of the vehicle is not impeded. Cables and hoses must not rub against each other and/or be hindered in any way.

 **WARNING:** Carry out a comprehensive functionality check before you start to drive. Check the tightening torque of all connections and the tight fit of the product after the first 50 km and then at regular intervals. Mounted accessories can change the handling and stability of the vehicle.



SW-MOTECH GmbH & Co. KG  
Ernteweg 7-10  
35282 Rauschenberg  
Germany



 [info@sw-motech.com](mailto:info@sw-motech.com)  
 [www.sw-motech.com](http://www.sw-motech.com)



Take note of the symbols and what they mean in the ASSEMBLY section. If the term OEM appears in the ASSEMBLY section, the vehicle manufacturer's specifications must be observed and applied.



If you have any questions, please don't hesitate to contact our Customer Service team or our distributors. You can find our telephone number and a list of our distributors in our online shop:

[www.sw-motech.com](http://www.sw-motech.com)



**Use thread locker:** Indicates that a thread must be coated with liquid thread locker. H (HIGH): high strength; M (MEDIUM): medium strength; L (LOW): low strength.



**Tighten/note the tightening torque information:** Indicates the tightening torque of a part specified by SW-MOTECH or the vehicle manufacturer (OEM).



**Do not use thread lock:** Indicates that no liquid thread lock should be used at this point.

**PARTS LIST - READ AND KEEP MOUNTING INSTRUCTIONS!**

<b>2</b>	<b>1</b> 	<b>2</b> 	<b>3</b> 	<b>4</b> 	<b>5</b> 	<b>6</b> 	
	KFT.22.822.001.11 📦 2/2	M8 x 40; DIN 912 SC.ST.08.040.48.912.109 📦 4/4	KFT.05.440.007.11 📦 4/4	M8 x 35; DIN 6912 SC.ST.08.035.02.6912.088 📦 4/4	ø 8,4; DIN 125 US.ST.084.02.125 📦 4/4	Ø 20 / Ø 8.4 / h 14.5 DB.ST.0200.0084.0145.02 📦 4/4	
	<b>3</b>	<b>7</b> 	<b>8</b> 	<b>9</b> 	<b>10</b> 		
		KFT.06.525.005.11 📦 1/1	M6 x 25; ISO 7380 SC.ST.06.025.02.7380.109 📦 3/3	Ø 20 / Ø 6.4 / h 5 DB.ST.0200.0064.0050.02 📦 1/1	M6; DIN 6927 MU.ST.06.02.6927.08 📦 3/3		
		<b>4</b>	<b>11</b> 	<b>12</b> 	<b>13</b> 		
			KFT.22.995.971.01.11 📦 1/1	KFT.22.995.972.01.11 📦 1/1	KFT.00.152.SV.8 📦 1/1		

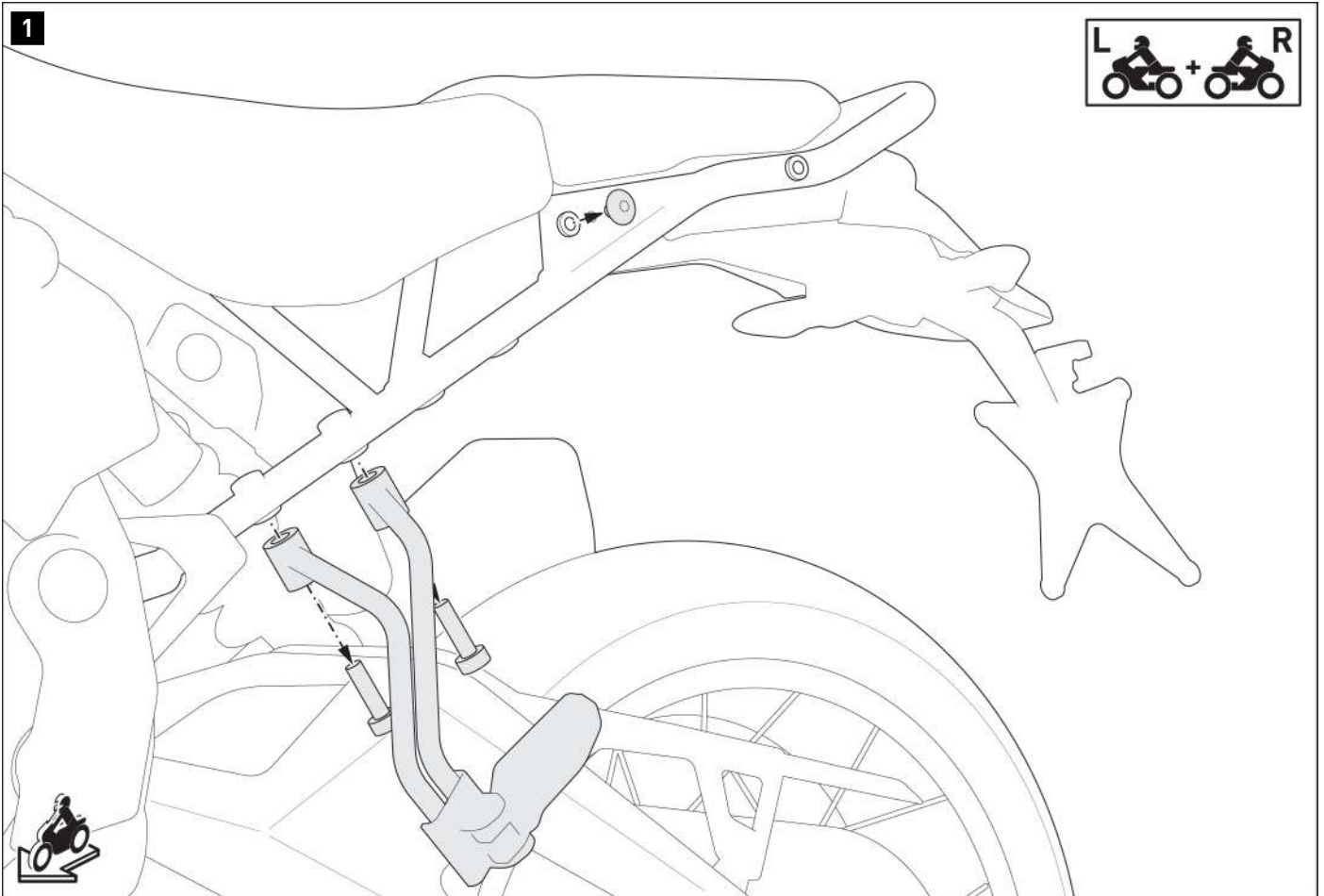

**▲WARNING: Always wear eye and hand protection!**  
**▲WARNING: Always use appropriate tools!**

Remove the screws indicated as well as the passenger footrests on both sides of the vehicle.

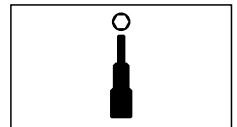

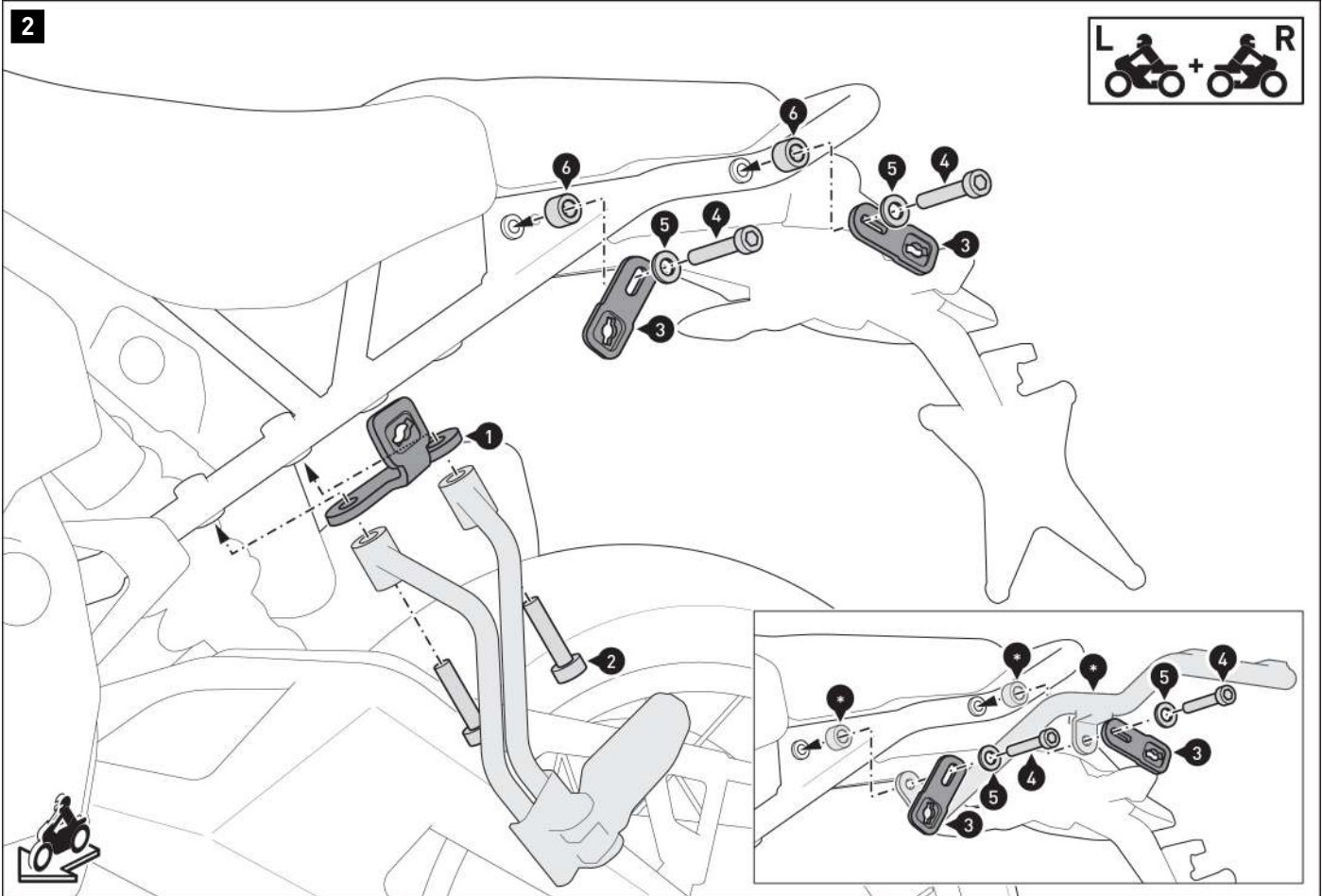

Screw the mounting brackets (1) to the passenger footrests on both sides of the vehicle.

**▲WARNING: Use a liquid threadlocker!**  
Do not tighten the screws (2) yet.

Screw the mounting brackets (3) to the rear of the vehicle on both sides.

**▲WARNING: Use a liquid threadlocker!**  
Do not tighten the screws (4) yet.

**△Note:** In order to mount the side carrier together with the SW-MOTECH rack, use the rack spacers (\*) as indicated in the detailed drawing.

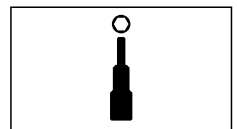



Screw the crossbar [7] to your license plate on the license plate holder.  
Do not tighten the screws yet.

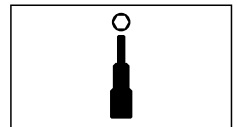

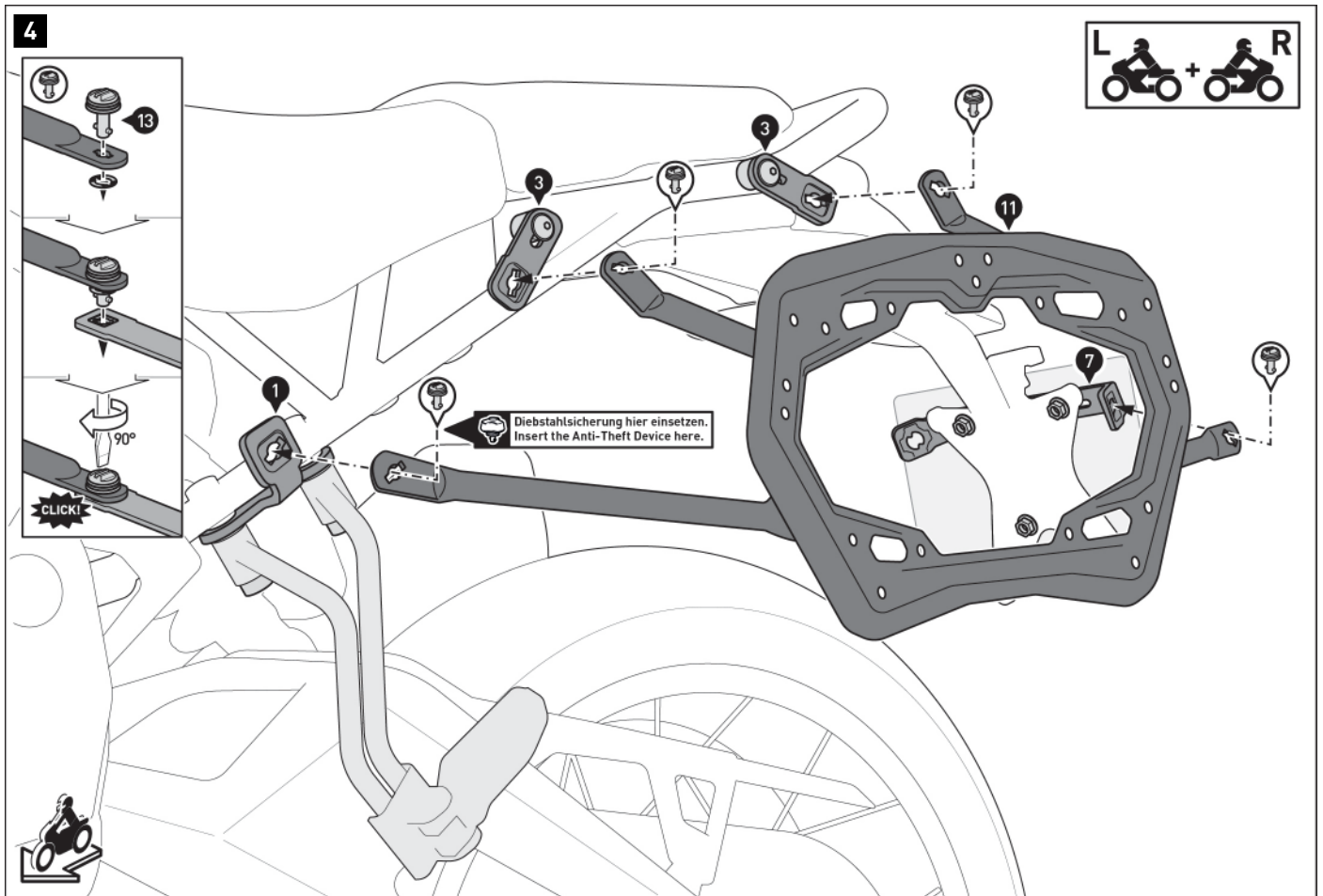

Using the quick-release fasteners, (13) connect the side carriers (11) and (12) to the mounting brackets (1) and (3) as well as to the crossbar (7). Secure the quick-release fasteners using the lock washers.

When all components are loosely in proper position, tighten the screws as specified.

⚠ **NOTE:** Anti-theft protection is sold separately.

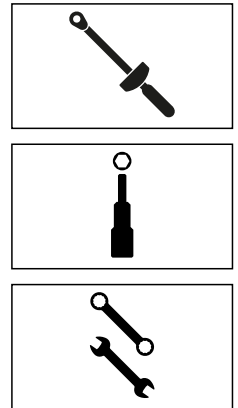
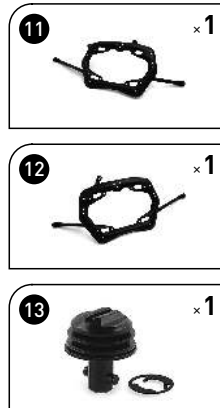



PRODUCT-SPECIFIC NOTES

**⚠ DANGER:** The specified maximum load includes the weight of the carrier adapter kit/luggage and adapter kit! The maximum vehicle load capacity specified by the vehicle manufacturer is applicable!

 ≤ 12.5KG (≤ 27.5 lbs) |  ≤ 130 km/h (≤ 80 mph)

**⚠ NOTE:** The side carriers have been designed exclusively for use with SW-MOTECH adapter kits.

**⚠ NOTE:** Dismantle the side carriers when riding without luggage. Always use the side carriers in pairs.

**⚠ WARNING:** Ensure that the cases are NOT in the exhaust gas flow after mounting them on the vehicle! Risk of burns!

**⚠ NOTE:** Ensure you adhere to country-specific regulations regarding the registration and operation of your vehicle or any applicable TÜV regulations. After assembly, parts that are subject to registration should be entered in the vehicle documents by your test center.

Art.-Nr. / Item No.: **KFT.00.152.35200**

Revision: **01** · Datum / Date: **10 - 2018**

**Adapterkit für PRO Seitenträger –  
AERO ABS**

**Adapter kit for PRO side carrier –  
AERO ABS**

**DEUTSCH** - Vielen Dank, dass Sie sich für dieses Premium-Produkt von SW-MOTECH entschieden haben. Bitte besuchen Sie unseren Webshop für weitere Informationen wie Modellzuweisungen und PDF-Anbauanleitung. Erforderliche Dokumente (z. B. ABE) stehen als Download zur Verfügung.

Die Montage und/oder Wartung dieses Produkts erfordert ein gutes technisches Verständnis! Zu Ihrer eigenen Sicherheit empfiehlt SW-MOTECH, die Montage und/oder Wartung durch eine Fachwerkstatt durchführen zu lassen! SW-MOTECH übernimmt keine Haftung für Schäden, die durch eine unsachgemäße Montage und/oder Wartung verursacht wurden!

Beachten Sie alle in der Anbauanleitung angegebenen Hinweise und die für die Montage relevanten Informationen im Fahrzeughandbuch. Nichtbeachtung kann zu Schäden am Fahrzeug bzw. zur Gefährdung des Fahrers führen! Diese Anbauanleitung ist nach unserem derzeitigen Kenntnisstand verfasst worden. Rechtliche Ansprüche auf Richtigkeit bestehen nicht.

Dieses Produkt wurde für Fahrzeuge im Werkzustand entwickelt. Die Kompatibilität mit Original-Zubehörteilen bzw. den Zubehörteilen anderer Hersteller kann nicht gewährleistet werden. Stellen Sie des Weiteren VOR Montage dieses Produkts sicher, dass sich alle beweglichen Teile (z. B. die Kette) im ursprünglichen Wartungszustand befinden. Montiertes Zubehör kann das Fahrverhalten und/oder die Stabilität Ihres Fahrzeugs verändern.

**ALLGEMEINE HINWEISE**

Beachten Sie die landesspezifischen Vorschriften für Zulassung/Betrieb Ihres Fahrzeugs bzw. anwendbare TÜV-Vorschriften. Lassen Sie eintragungspflichtige Teile nach Montage durch Ihre Prüfstelle in die Fahrzeugpapiere eintragen.

**VORBEREITUNG:** Lesen Sie die Anbauanleitung aufmerksam und stellen Sie sicher, dass alle Teile der Stückliste vorhanden sind. Achten Sie darauf, dass Ihr Fahrzeug sicher steht und nicht umfallen kann. Schalten Sie den Motor ab und ziehen Sie den Zündschlüssel. Lassen Sie ggf. den Motor/Auspuff abkühlen. Klemmen Sie bei Arbeiten an der Elektrik die Fahrzeugbatterie ab. Verwenden Sie geeignetes Werkzeug. Lassen Sie sich von einer zweiten Person helfen.

**MONTAGE:** Alle vom Motorrad gelösten Teile und Verbindungen sind gemäß den Fahrzeugherstellereangaben wieder zu montieren oder durch die von SW-MOTECH gelieferten Teile zu ersetzen. Sichern Sie, falls nicht anderweitig definiert, alle Gewinde mit mittelfester, flüssiger Schraubensicherung.

**Alle nicht durch SW-MOTECH definierten Anzugsmoment-Vorgaben müssen beim Fahrzeughersteller oder einer Fachwerkstatt erfragt werden!**

**FUNKTIONSKONTROLLE:** Stellen Sie nach der Montage sicher, dass alle zuvor gelösten Teile und Verbindungen wieder ordnungsgemäß montiert wurden. Achten Sie außerdem auf die uneingeschränkte Freigängigkeit und einwandfreie Funktion sämtlicher Fahrzeugteile. Kabel, Züge und Schläuche dürfen nicht scheuern und/oder geklemmt werden. Führen Sie vor Fahrtbeginn eine umfassende Funktionskontrolle durch. Überprüfen Sie nach den ersten 50 km und anschließend in regelmäßigen Abständen das Anzugsmoment aller Schraubverbindungen und den ordnungsgemäßen Sitz des Produkts.

**ENGLISH** - Thank you for choosing this premium product from SW-MOTECH. Please visit our webshop for additional information, such as application charts and PDF mounting instructions. Any other documents that may be required (e.g. ABE certifications), are also available for download at our webshop.

Installation and/or maintenance of this product require good technical understanding! For your own safety SW-MOTECH recommends having installation and/or servicing carried out by a specialist workshop! SW-MOTECH assumes no liability for damage caused by improper installation and/or maintenance work!

Carefully follow all the directions given in the mounting instructions and pay attention to all relevant information in the vehicle manual during assembly. Nonconformance can lead to vehicle damage or even endanger the driver! These mounting instructions are written based on our current state of knowledge. Legal requirements for accuracy do not exist.

This product was developed for vehicles in their factory setting. Compatibility with original accessory parts or other manufacturers' accessory parts is not guaranteed. Furthermore, BEFORE installing this product, make sure that all moving parts (e.g. the chain) are in the original state of maintenance. Installed accessories can change the driving behaviour and/or stability of your vehicle.

**GENERAL INFORMATION**

Observe the country-specific regulations concerning vehicle registration/operation as well as TÜV regulations if applicable. If required, register installed parts in the vehicle documents through an appropriate inspection authority.

**PREPARATION:** Read the mounting instructions carefully and make sure that all items of the parts list are included. Make sure that your vehicle is parked safely and cannot fall over. Turn off the engine and remove the ignition key. Let the motor/exhaust cool off if necessary. Disconnect the vehicle battery when working on the electrical system. Use appropriate tools. Have another person to help you.

**MOUNTING:** All parts and connections removed from the vehicle must be reinstalled in accordance with the vehicle manufacturers' specifications or replaced by parts delivered by SW-MOTECH. Secure all threads, unless otherwise specified, with medium-strength liquid thread locker.

**Torque specifications undefined by SW-MOTECH must be obtained from the vehicle manufacturer or by a specialist workshop!**

**FUNCTION CHECK:** After installation make sure that all parts and connections previously removed are properly replaced. Also make sure that no moving parts are obstructed and no function of the vehicle is hindered in any way. Cables and hoses must not rub and/or be pinched. Before starting to ride, perform a comprehensive check of all functions. After the first 50 km and then at regular intervals, check the tightening torque of all screw connections and the proper fit of the product.

Konfektionierung durch / Packed by:

Datum der Konfektionierung / Date of packaging:



**SW-MOTECH GmbH & Co. KG**

Ernteweg 8/10  
35282 Rauschenberg  
Germany

Tel. / phone + 49 (0)6425 / 8168 - 050  
Fax / fax + 49 (0)6425 / 8168 - 10

**info@sw-motech.com**  
**www.sw-motech.com**

# STÜCKLISTE / PARTS LIST

Schritt Step	Nr. No.	Art.-Nr. / Bezeichnung * Item No. / Description *	Artikel	Part	Anzahl ** Quantity **	N·m ***
(1)		BC.HTA.00.675.013	Verschlussbolzen	Lock Bolt	2 / 2	
(2)		M6 x 20; DIN 6912	Innensechskantschraube, fl. Kopf	Hexagon Socket Screw, short head	2 / 2	9
(3)		KFT.00.152.071	Führungsbolzen	Guide Bolt	6 / 6	
(4)		M6 x 20; DIN 7991	Senkkopfschraube	Countersunk Screw	6 / 6	9
(5)		M6; DIN 6927	Mutter mit Bund, selbstsichernd; schwarz	Lock Nut with Flange; black	8 / 8	

<b>8.8</b>	Regelgewinde / Coarse Thread Ø	<b>M4</b>	<b>M5</b>	<b>M6</b>	<b>M8</b>	<b>M10</b>	<b>M12</b>																	
	Stahl FK 8.8 / Steel CL 8.8	<b>N·m</b>	2,8	5,5	9,6	23	46	79																

\* Alle Maßangaben in Millimeter. - \*\* Der zweite Wert gibt die Gesamtanzahl des jew. Artikels in der Lieferung an.  
 \*\*\* **Keine Anzugsmomentvorgabe: Verwenden Sie das vom Fzg.-Hersteller definierte Anzugsmoment!** Das Standard-Anzugsmoment der Tabelle kann verwendet werden, wenn es den Fzg.-Hersteller-Vorgaben entspricht.

\* All measurements in millimeters. - \*\* The second number indicates the total quantity of the part in the delivery.  
 \*\*\* **No torque specifications: Use the torque defined by vehicle manufacturer!** The standard torque in this table can be used as long as it is within the vehicle manufacturer's specifications.

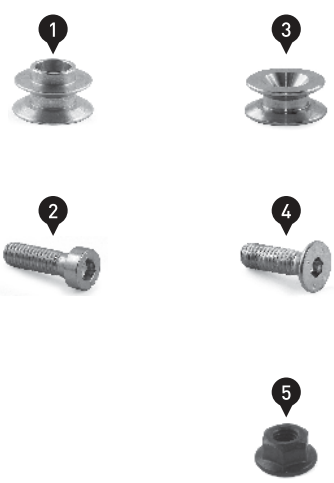

## MONTAGE / MOUNTING

PRO Seitenträger  
PRO side carrier



**HINWEIS:** Die Zeichnung zeigt die Montage am **rechten** PRO-Seitenträger. Montieren Sie die Teile am linken PRO-Seitenträger auf die gleiche Weise wie am rechten PRO-Seitenträger.

Verschrauben Sie die gezeigten Teile an ihren PRO-Seitenträgern (separat erhältlich). Ziehen Sie die Schrauben wie in der Stückliste vorgegeben an.

**NOTE:** The illustration shows the mounting to the **right** PRO side carrier. Mount the parts to the left PRO side carrier in the same way as to the right PRO side carrier.

Attach the shown parts to your PRO side carriers (sold separately). Tighten the screws as specified in the parts list.

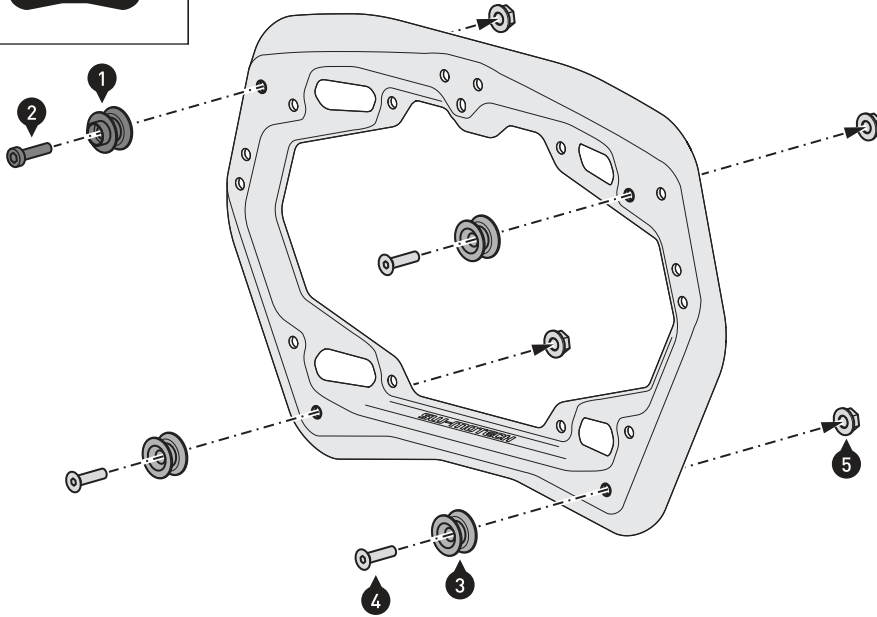

Art.-Nr. / Item No.: **BC.HTA.00.675.12000/B**

Revision: **02** · Datum / Date: **08 - 2020**

**AERO ABS Seitenkoffer-Set**

**AERO ABS side case set**

**DEUTSCH** - Vielen Dank, dass Sie sich für dieses Premium-Produkt von SW-MOTECH entschieden haben. Bitte besuchen Sie unseren Webshop für weitere Informationen wie Modellzuweisungen und PDF-Anbauanleitung. Erforderliche Dokumente (z. B. ABE) stehen als Download zur Verfügung.

Die Montage und/oder Wartung dieses Produkts erfordert ein gutes technisches Verständnis! Zu Ihrer eigenen Sicherheit empfiehlt SW-MOTECH, die Montage und/oder Wartung durch eine Fachwerkstatt durchführen zu lassen! SW-MOTECH übernimmt keine Haftung für Schäden, die durch eine unsachgemäße Montage und/oder Wartung verursacht wurden!

Beachten Sie alle in der Anbauanleitung angegebenen Hinweise und die für die Montage relevanten Informationen im Fahrzeughandbuch. Nichtbeachtung kann zu Schäden am Fahrzeug bzw. zur Gefährdung des Fahrers führen! Diese Anbauanleitung ist nach unserem derzeitigen Kenntnisstand verfasst worden. Rechtliche Ansprüche auf Richtigkeit bestehen nicht.

Dieses Produkt wurde für Fahrzeuge im Werkzustand entwickelt. Die Kompatibilität mit Original-Zubehörteilen bzw. den Zubehörteilen anderer Hersteller kann nicht gewährleistet werden. Stellen Sie des Weiteren VOR Montage dieses Produkts sicher, dass sich alle beweglichen Teile (z. B. die Kette) im ursprünglichen Wartungszustand befinden. Montiertes Zubehör kann das Fahrverhalten und/oder die Stabilität Ihres Fahrzeugs verändern.

**ALLGEMEINE HINWEISE**

Beachten Sie die landesspezifischen Vorschriften für Zulassung / Betrieb Ihres Fahrzeugs bzw. anwendbare TÜV-Vorschriften. Lassen Sie eintragungspflichtige Teile nach Montage durch Ihre Prüfstelle in die Fahrzeugpapiere eintragen.

**VORBEREITUNG:** Lesen Sie die Anbauanleitung aufmerksam und stellen Sie sicher, dass alle Teile der Stückliste vorhanden sind. Achten Sie darauf, dass Ihr Fahrzeug sicher steht und nicht umfallen kann. Schalten Sie den Motor ab und ziehen Sie den Zündschlüssel. Lassen Sie ggf. den Motor / Auspuff abkühlen. Klemmen Sie bei Arbeiten an der Elektrik die Fahrzeugbatterie ab. Verwenden Sie geeignetes Werkzeug. Lassen Sie sich von einer zweiten Person helfen.

**FUNKTIONSKONTROLLE:** Da es sich um ein universelles Produkt handelt, stellen Sie unbedingt VOR der ersten Nutzung sicher, dass sich das Produkt ohne Probleme und sachgerecht an Ihrem Fahrzeugtyp befestigen und verwenden lässt. Achten Sie nach der Befestigung auf die uneingeschränkte Freigängigkeit und einwandfreie Funktion sämtlicher Fahrzeugteile. Leuchtmittel wie Rücklicht und Blinker dürfen nicht in ihrer Funktion eingeschränkt werden. Kabel, Züge und Schläuche dürfen nicht scheuern und/oder geklemmt werden. Führen Sie vor Fahrtbeginn eine umfassende Funktionskontrolle durch.

**PRODUKTSPEZIFISCHE HINWEISE**

**ACHTUNG:** Das Fahr-/Bremsverhalten des Motorrads verändert sich nach Befestigung dieses Produkts merklich!

**ACHTUNG:** Je nach Ort der Befestigung kann die Kurven- und Bodenfreiheit durch dieses Produkt eingeschränkt werden!

**ACHTUNG:** Überprüfen Sie vor Fahrtbeginn und bei jeder Rast (alle 200 km) den ordnungsgemäßen Sitz des Produkts!

<b>Maximale Zuladung</b>	<b>Höchstgeschwindigkeit</b>
 <b>10 KG (22 lbs) pro Koffer</b>	 <b>130 km/h (80 mph)</b>

**ACHTUNG:** Die Zuladung des verwendeten SW-MOTECH Seitenträgers darf nicht überschritten werden (siehe Anbauanleitung des Seitenträgers)! Es gilt die vom Fahrzeughersteller genannte maximale Zuladung des Fahrzeugs!

**ACHTUNG** 

**NICHT FÜR DEN OFFROAD-EINSATZ GEEIGNET!**

**ENGLISH** - Thank you for choosing this premium product from SW-MOTECH. Please visit our webshop for additional information, such as application charts and PDF mounting instructions. Any other documents that may be required (e.g. ABE certifications), are also available for download at our webshop.

Installation and/or maintenance of this product require good technical understanding! For your own safety SW-MOTECH recommends having installation and/or servicing carried out by a specialist workshop! SW-MOTECH assumes no liability for damage caused by improper installation and/or maintenance work!

Carefully follow all the directions given in the mounting instructions and pay attention to all relevant information in the vehicle manual during assembly. Nonconformance can lead to vehicle damage or even endanger the driver! These mounting instructions are written based on our current state of knowledge. Legal requirements for accuracy do not exist.

This product was developed for vehicles in their factory setting. Compatibility with original accessory parts or other manufacturers' accessory parts is not guaranteed. Furthermore, BEFORE installing this product, make sure that all moving parts (e.g. the chain) are in the original state of maintenance. Installed accessories can change the driving behaviour and/or stability of your vehicle.

**GENERAL INFORMATION**

Observe the country-specific regulations concerning vehicle registration / operation as well as TÜV regulations if applicable. If required, register installed parts in the vehicle documents through an appropriate inspection authority.

**PREPARATION:** Read the mounting instructions carefully and make sure that all items of the parts list are included. Make sure that your vehicle is parked safely and cannot fall over. Turn off the engine and remove the ignition key. Let the motor / exhaust cool off if necessary. Disconnect the vehicle battery when working on the electrical system. Use appropriate tools. Have another person to help you.

**FUNCTION CHECK:** This is a universal product. For this reason make sure BEFORE the first use, that the product can be fixed properly and used without problems with your vehicle type. After fixation also make sure that no moving parts are obstructed and the function of the vehicle is not hindered in any way. Lamps as taillight and turn signals must not be limited in their function. Cables and hoses must not rub and/or be pinched. Before starting to ride, perform a comprehensive check of all functions.

**PRODUCT SPECIFIC INFORMATION**

**ATTENTION:** Riding with this product may affect the motorcycles driving and braking performance!

**ATTENTION:** Depending on the location of fixation, cornering and ground clearance can be reduced by using this product!

**ATTENTION:** Before riding and at each stop (every 200 km) check proper fixation of the product!

<b>Maximum Load</b>	<b>Maximum Speed</b>
 <b>10 KG (22 lbs) per case</b>	 <b>130 km/h (80 mph)</b>

**ATTENTION:** The maximum load of the used SW-MOTECH side carrier must not be exceeded (refer mounting instructions of the side carrier)! The maximum vehicle load specified by the manufacturer must not be exceeded!

**ATTENTION** 

**NOT FOR OFFROAD-USE!**

Konfektionierung durch / Packed by:

Datum der Konfektionierung / Date of packaging:



**SW-MOTECH GmbH & Co. KG**  
Ernteweg 8/10  
35282 Rauschenberg  
Germany

Tel. / phone + 49 (0)6425 / 8168 - 050  
Fax / fax + 49 (0)6425 / 8168 - 10  
**info@sw-motech.com**  
**www.sw-motech.com**

# STÜCKLISTE / PARTS LIST

Schritt Step	Nr. No.	Art.-Nr. / Bezeichnung * Item No. / Description *	Artikel	Part	Anzahl ** Quantity **	N-m ***
1	(1)	BC.HTA.00.675.901 / 902.01	AERO ABS Seitenkoffer; links / rechts	AERO ABS Side Case; left / right	2 / 2	
4	(2)	BC.LOC.00.001.10200/B	Motorradtaschen-Schloss	Lock for Motorcycle Luggage	2 / 2	
	(3)	BC.ZUB.00.104.30000	Wasserdichte Innentasche	Waterproof Inner Bag	2 / 2	

8.8	Regelgewinde / Coarse Thread Ø	M4	M5	M6	M8	M10	M12	10.9	Regelgewinde / Coarse Thread Ø	M4	M5	M6	M8	M10	M12	
	Stahl FK 8.8 / Steel CL 8.8	N-m	2,8	5,5	9,6	23	46	79	Stahl FK 10.9 / Steel CL 10.9	N-m	4,1	8,1	14	34	67	115

\* Alle Maßangaben in Millimeter. - \*\* Der zweite Wert gibt die Gesamtanzahl des jew. Artikels in der Lieferung an.  
 \*\*\* **Keine Anzugsmomentvorgabe: Verwenden Sie das vom Fzg.-Hersteller definierte Anzugsmoment!** Das Standard-Anzugsmoment der Tabelle kann verwendet werden, wenn es den Fzg.-Hersteller-Vorgaben entspricht.  
 \* All measurements in millimeters. - \*\* The second number indicates the total quantity of the part in the delivery.  
 \*\*\* **No torque specifications: Use the torque defined by vehicle manufacturer!** The standard torque in this table can be used as long as it is within the vehicle manufacturer's specifications.

**1**



**4**



**3**

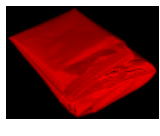

### PFLEGE / CARE

**Pflege**

Verwenden Sie zum Reinigen der Seitenkoffer warme Seifenlauge und ein weiches, sauberes Tuch. Spülen Sie anschließend mit klarem Wasser nach.

**Verwenden Sie KEINE scharfen Reinigungsmittel, raue Putzutensilien oder einen Hochdruckreiniger!** Reinigen Sie die Seitenkoffer unbedingt nach Winterfahrten, um Schäden durch das Salz zu vermeiden.

Schwergängige Reißverschlüsse können mit etwas Talkumpulver wieder gängig gemacht werden.

**ACHTUNG: Oberflächenmaterialien können bei längerer und intensiver Sonneneinstrahlung und Umwelteinflüssen (z. B. SMOG, saurer Regen, etc.) Farbveränderungen (Ausbleichen) unterliegen! Dafür übernimmt SW-MOTECH keine Haftung.**

**Care**

To clean the side cases, use warm, soapy water and a soft, clean cloth. Rinse with clean water.

**Do NOT use strong cleaning agents, rough cleaning tools or high pressure washer!** Clean the side cases after riding in salty conditions, to avoid damage from salt.

Hard to open zippers can be loosened with a small amount of talcum powder.

**ATTENTION: Surface materials can experience color changes or fading when exposed to direct sunlight for extended periods of time and by environmental factors (e.g., SMOG, acid rain, etc.)! SW-MOTECH assumes no liability for this.**

✓ OK

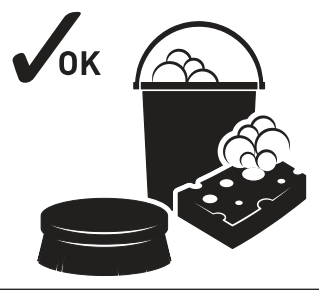







**Schritt [1]:** Setzen Sie die vier Arretierungsöffnungen des Seitenkoffers (1) auf die Führungsbolzen des montierten SW-MOTECH Seitenträgers.

**Schritt [2]:** Drücken Sie den Seitenkoffer leicht nach unten, bis dieser fest am Seitenträger sitzt. **ACHTUNG: Achten Sie darauf, dass alle vier Führungsbolzen gleichzeitig einrasten! Achten Sie außerdem auf das deutlich hörbare Einrastgeräusch des Verschlussmechanismus und dass die rote Markierung unter dem Schieber nicht sichtbar ist!**

Drücken Sie zum Entriegeln den Schieber nach unten.

**ACHTUNG: Achten Sie darauf, dass keine Komponenten des Seitenkoffers mit heißen und beweglichen Teilen des Fahrzeugs in Kontakt kommen können! Achten Sie des Weiteren darauf, dass alle Komponenten mindestens 5 cm Abstand zu heißen Teilen sowie dem heißen Abgasstrom des Auspuffs haben! Stellen Sie nach der Montage sicher, dass dieser Abstand in jedem Federzustand des Fahrzeugs eingehalten wird!**

**Schritt [3]:** Um den montierten Seitenkoffer (1) gegen Diebstahl zu schützen, muss dieser zunächst geöffnet werden.

Drücken Sie nun den Sicherungsknopf und drehen ihn gemäß der Pfeilmarkierung, bis der Sicherungsknopf einrastet.

**Schritt [4]:** Verriegeln Sie nun die Puller des geschlossenen Reißverschlusses mit dem beiliegenden Schloss (2). Wir empfehlen, den Sicherungsknopf während der Fahrt immer in der abgeschlossenen Position zu belassen.

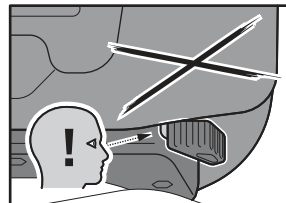

SICHTBARE ROTE MARKIERUNG: NICHT korrekt verriegelt! Verlustgefahr!  
VISIBLE RED MARKING: NOT correctly locked! Risk of loss!

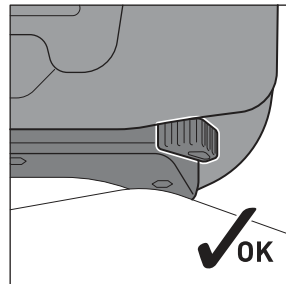

**Step [1]:** Place the four locking openings of the side case (1) onto the guide bolts of the mounted SW-MOTECH side carrier.

**Step [2]:** Press the side case slightly downward, until it properly rests on the side carrier.

**ATTENTION: Make sure that all four guide bolts engage at the same time! Pay attention to the clearly audible snap sound of the locking mechanism and that the red marking under the slider is not visible!**

To release press the slider downward.

**ATTENTION: All components of the side case must not contact any hot or moving parts of the vehicle! All parts should also remain 5 cm away from hot parts of the vehicle and remain clear of the exhaust stream! After mounting, make sure there are no clearance issues while the suspension is both compressed and extended.**

**Step [3]:** To protect the mounted side case against theft, open it (1). Then press the locking button and turn it according to the arrow mark until the locking button engages.

**Step [4]:** Then lock the closed zipper with the included lock (2). We recommend leaving the locking button in the closed position during the ride.

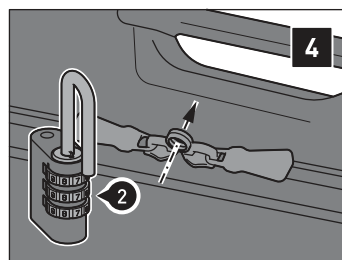
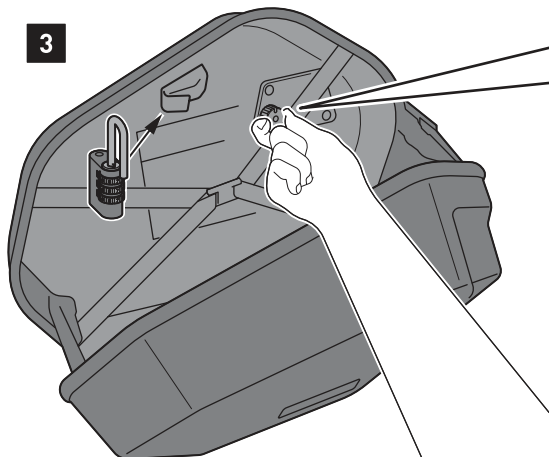
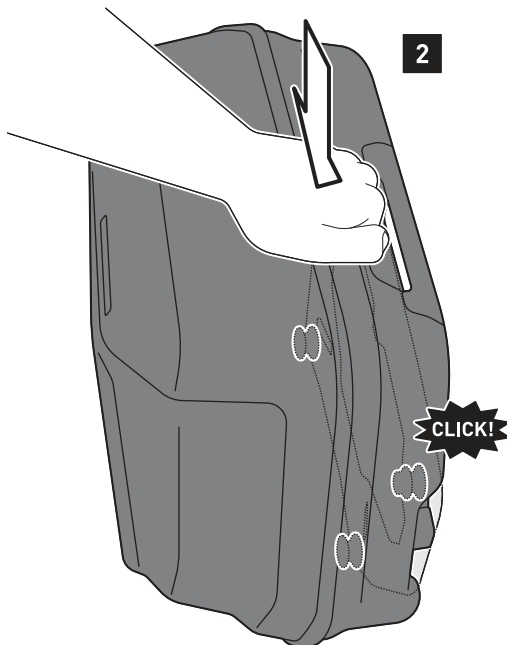

## MONTAGE / MOUNTING



Verwenden Sie die beiliegende wasserdichte Innentasche (3), um Ihr Gepäck vor Feuchtigkeit zu schützen.

Use the included waterproof inner bag (3) to protect your luggage from moisture.



Um den Seitenkoffer (1) einfacher beladen zu können, öffnen Sie die Schnallen und Klettverschlüsse der Öffnungsreduzierungen, wie in der Zeichnung gezeigt.

For an easier loading of the side case (1), open the buckles and hook and loop fasteners of the opening reductions, as shown in the drawing.



**ACHTUNG:** Achten Sie bei beidseitiger Verwendung der Seitenkoffer auf die gleichmäßige Verteilung der Ladung! Stellen Sie sicher, dass die Ladung während der Fahrt gegen Verrutschen gesichert ist!

**ACHTUNG:** Achten Sie darauf, niemals scharfkantige, spitze oder ähnliche Gegenstände zu verstauen, welche Verletzungen an Personen bzw. Beschädigungen am Fahrzeug/Seitenkoffer verursachen könnten!

**ATTENTION:** Make sure weight is evenly distributed between the left and right side if you want to use both side cases! Make sure that the loading is secured against shifting during the ride!

**ATTENTION:** Never store pointy or sharp-edged objects, which could cause injury to persons or damage to the vehicle/side case!



## ANBAUANLEITUNG / MOUNTING INSTRUCTIONS

Art.-Nr. / Item No.: **QLS.00.095.1000\*/B** · Revision: **00** · **01 - 2021**  
**QLS.00.046.1010\*/B**

### Diebstahlsicherung für PRO / EVO Seitenträger Anti-theft protection for PRO / EVO side carrier

#### ACHTUNG / ATTENTION

**NIEMALS** die Schließzylinder mit **ÖL** schmieren! Verwenden Sie nur **Graphitpulver!** **NEVER** lubricate lock cylinders with oil! Use **graphite powder** only!



Nr. No.	Art.-Nr. / Bezeichnung Item No. / Description	Anzahl Quantity
	<b>QLS.00.095.1000* (PRO)</b>	
(1)	QLS.00.095.520	2 / 2
(2)	SV.ST.095.007.LK.02	2 / 2
(3)	ALK.00.165.A63	2 / 2
	<b>QLS.00.046.1010* (EVO)</b>	
(1)	QLS.00.046.520	2 / 2
(2)	CAM.2312S10-1BP	2 / 2
(3)	ALK.00.165.A63	2 / 2

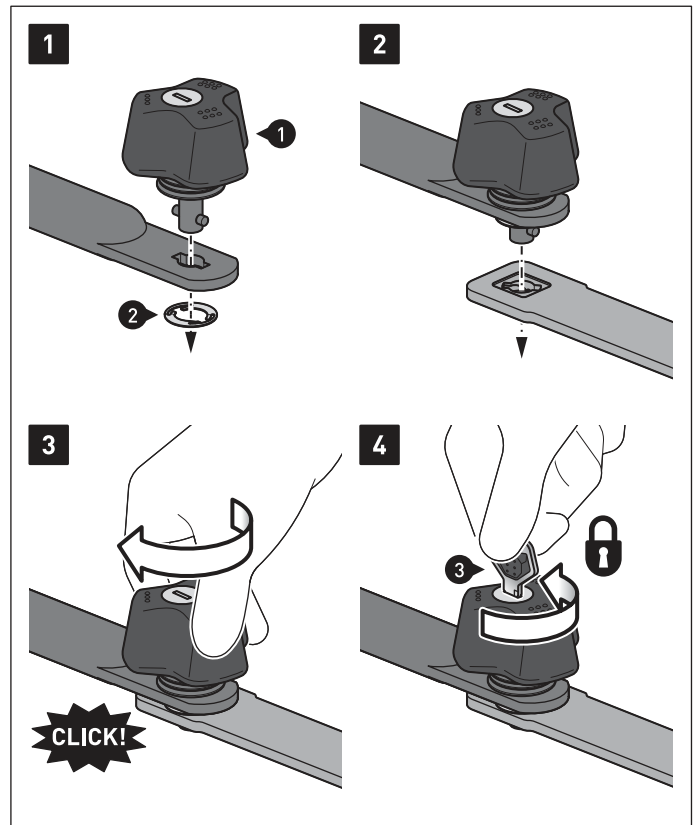

Irrtümer und Änderungen vorbehalten. Technische und Design-Änderungen vorbehalten.  
 Errors and omissions excepted. Technical and design modifications are subject to change.

Copyright by  
 SW-MOTECH GmbH & Co. KG

## ANBAUANLEITUNG / MOUNTING INSTRUCTIONS

Art.-Nr. / Item No.: **QLS.00.095.1000\*/B** · Revision: **00** · **01 - 2021**  
**QLS.00.046.1010\*/B**

### Diebstahlsicherung für PRO / EVO Seitenträger Anti-theft protection for PRO / EVO side carrier

#### ACHTUNG / ATTENTION

**NIEMALS** die Schließzylinder mit **ÖL** schmieren! Verwenden Sie nur **Graphitpulver!** **NEVER** lubricate lock cylinders with oil! Use **graphite powder** only!



Nr. No.	Art.-Nr. / Bezeichnung Item No. / Description	Anzahl Quantity
	<b>QLS.00.095.1000* (PRO)</b>	
(1)	QLS.00.095.520	2 / 2
(2)	SV.ST.095.007.LK.02	2 / 2
(3)	ALK.00.165.A63	2 / 2
	<b>QLS.00.046.1010* (EVO)</b>	
(1)	QLS.00.046.520	2 / 2
(2)	CAM.2312S10-1BP	2 / 2
(3)	ALK.00.165.A63	2 / 2

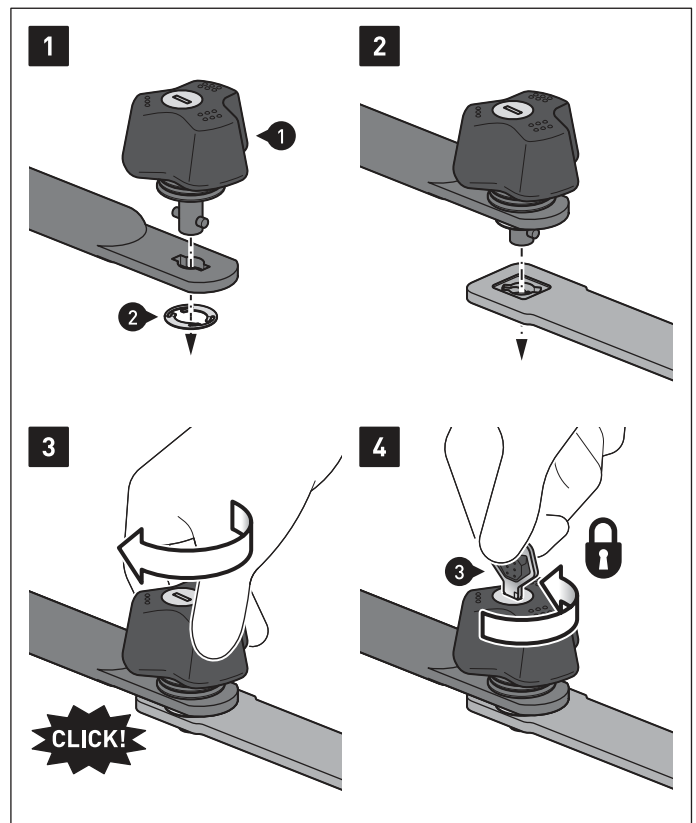

Irrtümer und Änderungen vorbehalten. Technische und Design-Änderungen vorbehalten.  
 Errors and omissions excepted. Technical and design modifications are subject to change.

Copyright by  
 SW-MOTECH GmbH & Co. KG